

GEMINI

Overview

The RGM150 Series is a 150W integrated 2U rackmount power system that incorporates system power, lock power and Mercury controllers.

RGM enclosures provide mounting for two Mercury controllers and multiple Life-Safety Power FlexPower® devices in an access control system capable of controlling four doors as a standalone or multiple doors when interconnected. LSP power modules are provided based on RGM model number and Mercury controllers are provided by the integrator based on the job requirements.

Available options include single (12 or 24V DC) or dual voltage operation (12 and 24V DC), power distribution and control, individual output protection by either fuses or class 2 power limiting, buffered lock control, and remote reporting and test. Each LSP output is protected against electrical surges caused by lightning or transients on the external wiring (SurgeShield™) and each LSP control output is individually selectable for available DC voltages, either failsafe or failsecure operation with fire alarm interface.

Optional network reporting capabilities include: operational fault status; power supply output; battery charging voltage; battery charging current; and fire alarm input status. In addition to automated and scheduled status reports, diagnostic servicing and battery load tests can be performed remotely, saving or reducing the cost of on-site servicing.

The unit is intended for mounting within a standard four post EIA 19 inch electronics rack with a maximum depth of 36 inches.

Rackmount Features

- Integrated access system with lock and system power distribution
- Compartmentalized architecture for maximum reliability
- Rack drawer slide assembly simplifies controller wiring and maintenance
- Comprehensive wire management with tie down points and articulating bracket
- 120 or 230V AC user selectable input supports data center electrical systems

Configuration Options

- Single voltage or 12 and 24VDC dual voltage options cover all access functions
- Power distribution for either direct (D8) buffered (C8) or managed (M8)
- Individual output selection for failsafe, failsecure, lock voltage and fire alarm interface
- High capacity battery charge capability
- Automotive fuses for ease of service and replaceability
- Easy door expansion with multiple Gemini drawers
- Available companion battery housing for rackmount use (part number RBE)

Network Monitoring

- Monitor/alert power supply, battery operation and faults
- Remote test battery run time, low battery and time to service alert
- Monitor/power cycle individual outputs (M8N model)
- Monitor alert external room temperature

Fire Alarm Interface

- Latching or Non-latching | Remote reset capability
- Normally Open, Normally Closed
- Voltage or Polarity Reversal Activation

Comprehensive fault detection and reporting

- May be connected into access controller or used standalone
- Form C contact transfer for AC Loss or brownout
- Form C contact transfer for abnormal system operation

Agency Listings

- UL, CUL, CE Access Control

Lifetime Warranty

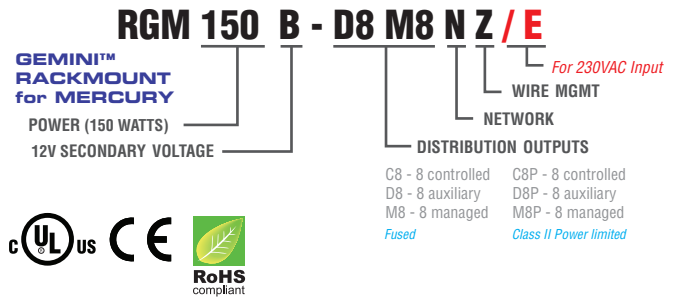

Ordering

*Model No.	Network	Voltage	Current	Internal Distribution			
				Bulk	Auxiliary	Control	Managed
RGM150-D8PZ		12V or 24V	12A/12V or 6A/24V	2	8		
RGM150-C8PZ				2		8	
RGM150-M8PNZ	Yes			2			8
RGM150B-D8PZ		12V and 24V	4A/12V and 4A/24V	2	8		
RGM150B-C8PZ				2		8	
RGM150B-M8PNZ	Yes			2			8

Single voltage - factory set to 12VDC

Dual voltage - outputs can be individually set for 12V or 24VDC

Networking - monitors power supply, battery set and relay control outputs

For CE 230VAC option, add "/ E" suffix to model number, i.e RGM150-D8PZ/E

Specifications

Input Power	Input 120/230 VAC 50/60 Hz 170 Watts Thermal overload protection / Short circuit protection
Output Power	RGM150 150 Watts: 12 amps at 12 VDC or 6 amps at 24 VDC (factory default setting is 12VDC) RGM150B 150 Watts: 4 amps at 12 VDC and 4 amps at 24 VDC (factory set to 24VDC and 12VDC) (allows 2A per controller and 0.50A per lock. If controller draws is less, lock power can be more)
Internal Power Distribution	D8/D8P eight auxiliary outputs: D8 fused at 3A/ea, D8P Class II Power limited at 2.5A/ea C4/C4P four control outputs: C4 fused at 3A/ea, C4P Class II Power limited at 2.5A/ea M8/M8P eight managed outputs: M8 fused at 3A/ea, M8P Class II Power limited at 2.5A/ea – Individually selectable outputs on dual voltage systems
Supervision	AC input, DC1, and DC2 output Low battery and battery presence supervision (form C contacts) AC fail supervision (form C contacts) System Fault, AC Fault, Ground Fault, Reverse Battery
External Indicators	AC on master on/off switch Front Panel Mercury Security Status LEDs
Battery Charging	Maximum charge current 2.0 amp Maximum battery capacity 80Ah Independent built-in charger for sealed lead acid or gel type batteries Microprocessor dual rate charging of 12 or 24 V battery sets Automatic switchover to standby battery when AC fails Zero voltage drop when switched over to battery backup
Regulatory Compliance	CE UL294 6th Edition, UL603, UL1076, ULC S318, ULC S319 (Mix and match Mercury and LSP modules together)
Access Panel Mounting	Two slots for EP1502, EP2500, MR52
BTU Rating	RGM150, RGM150B 66BTU/Hr
Physical Dimensions	2U rack mount (19.00"W x 3.50"H x 20.50"D) Weight 24 lbs. Z bracket wire management articulating arm

Drawer layout example of 4 door dual voltage

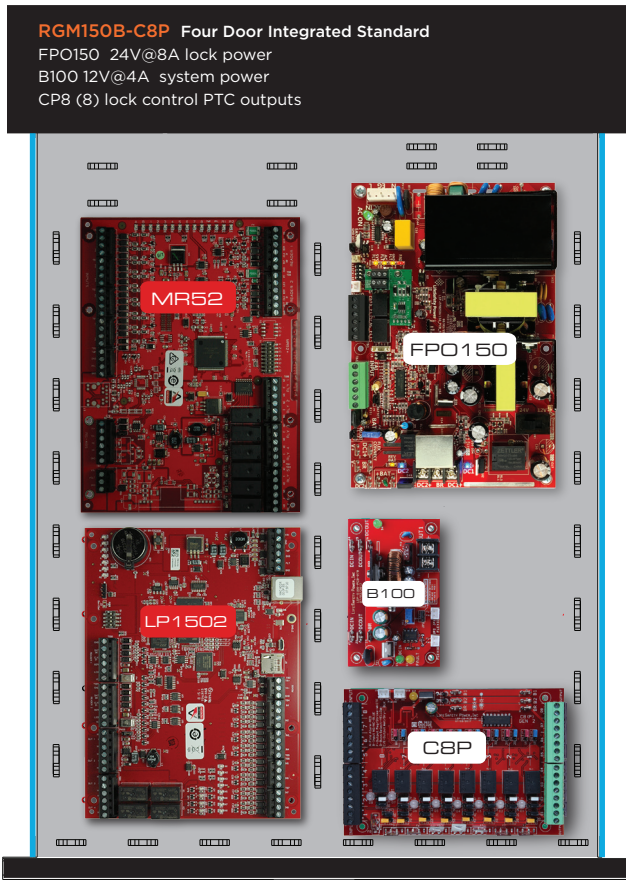

Drawer layout example of 4 door dual voltage managed system

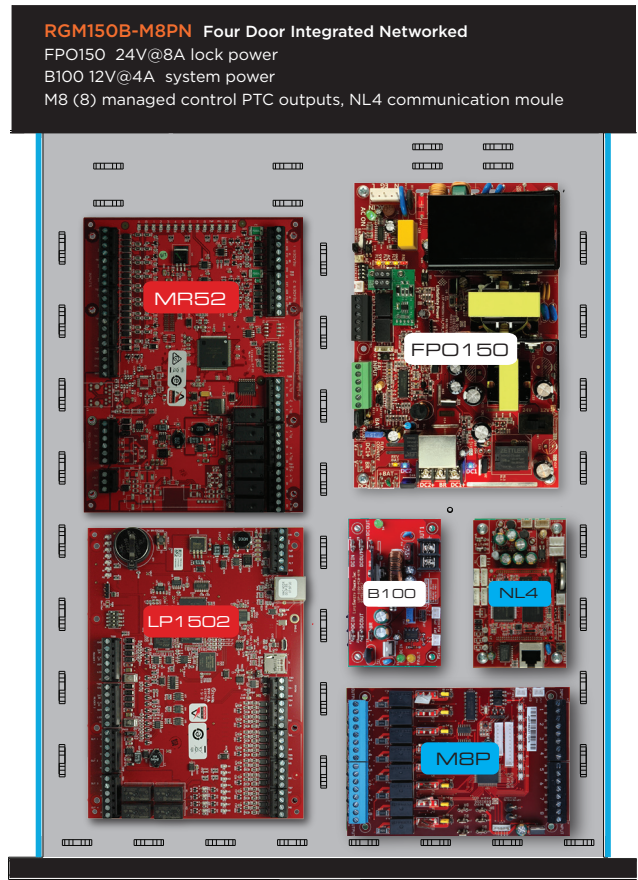

INTERNAL POWER DISTRIBUTION options

DISTRIBUTED POWER TO MERCURY RGM150-D8P (D8)

Eight individually protected power outputs

- D8P Class 2 power limited at 2.5A per output
- D8 Fused at 3A per output

Visual Indicators

- DC Presence: Green LED per output

Removable terminals

- Accepts #12 to #24 AWG

CONTROL OUTPUTS FOR LOCKS RGM150B-C4P (C4)

4 access control trip inputs

4 individually protected lock control outputs

- C4P Class 2 power limited at 2.5A per output
- C4 Fused at 3A per output

Each input may be programmed to respond to:

- Application of voltage between 9 and 33VDC
- Removal of voltage between 9 and 33VDC
- Normally open dry contact transition
- Normally closed dry contact transition

Each output may be programmed for the following modes:

- Voltage output from power supply one
- Voltage output from power supply two
- Fail-safe, Fail-secure
- Fire alarm over ride for egress lock control

Visual Indicators

- DC Presence: Green LED per output
- Fault Condition: Yellow fault LED

Removable terminals

- Accepts #12 to #24 AWG

MANAGED OUTPUTS FOR LOCKS & MERCURY RGM150B-M8P (M8)

8 access control trip inputs

8 individually protected managed control outputs

- M8P Class 2 power limited at 2.5A per output
- M8 Fused at 3A per output

Each input may be programmed to respond to:

- Application of voltage between 9 and 33VDC
- Removal of voltage between 9 and 33VDC
- Normally open dry contact transition
- Normally closed dry contact transition
- Activation or deactivation through software

Each output may be programmed for the following modes:

- Voltage output from power supply one
- Voltage output from power supply two
- Fail-safe, Fail-secure
- Fire alarm over ride for egress lock control
- AC loss over ride for egress lock control
- Trigger points based on voltage or current values to send an alert via email or SNMP

Visual Indicators

- DC Presence: Green LED per output
- Fault Condition: Yellow fault LED

Removable terminals

- Accepts #12 to #24 AWG

FAULT DETECTION AND REPORTING

DETECTED FAULT CONDITIONS (ALL MODELS)

AC Power

- AC loss, AC low, Master AC power switch

DC Power and System

- Abnormal or loss of power supply operation
- Over current, over temperature condition
- DC output high, low
- Battery Presence, Earth Ground (user optional)
- Reversed battery condition, blown fuse or loss of output voltage on selected accessory boards (detected on the power supply)

EXPANSION | BATTERY BACK-UP

8-16 Doors

- Stack multiple Gemini rack mounts for higher door counts
- Add RBE battery enclosure for battery back up

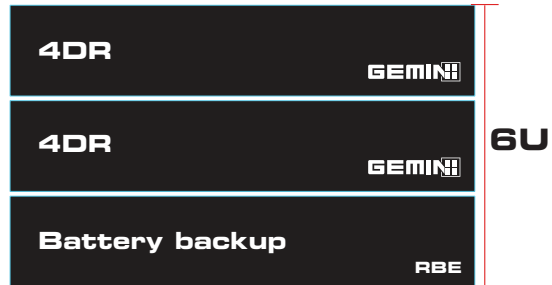

8 door battery back up

WIRE MANAGEMENT

Wire tie points

- Drawer tie down points for access wiring
- Back chassis tie down points secures wire bundle

Articulating arm

- Z bracket with tie wrap points secures access wiring into drawer

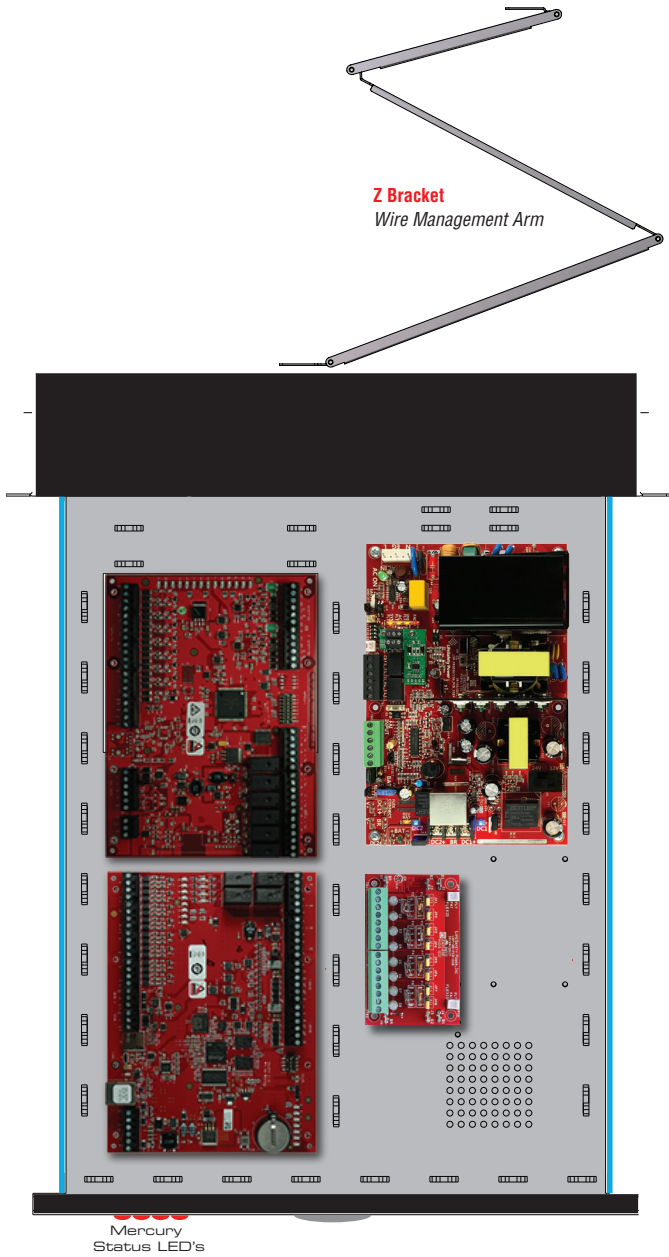

BACKPLATE CONFIGURATION OPTIONS

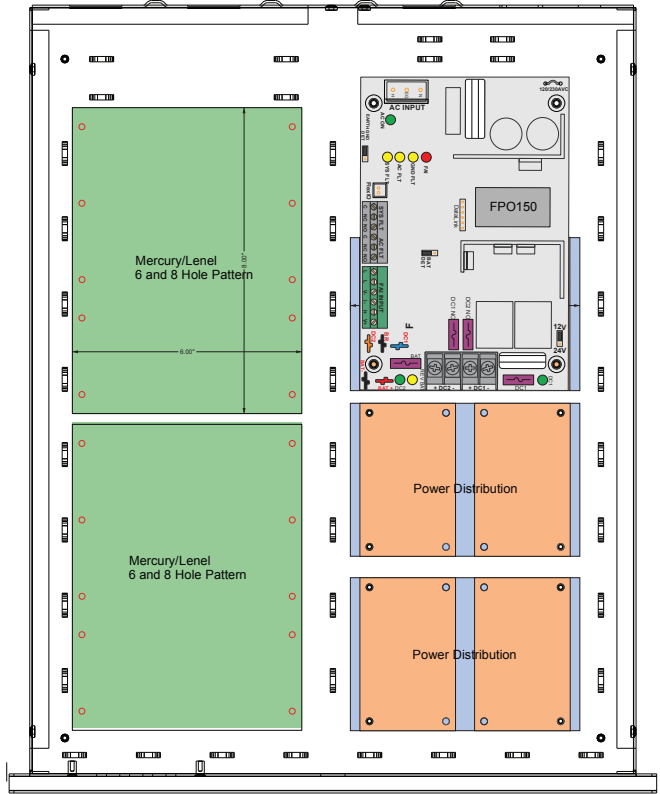

Mechanical

2U rack mount 19.00"W x 3.50"H x 20.50"D
 Weight 27 lbs.

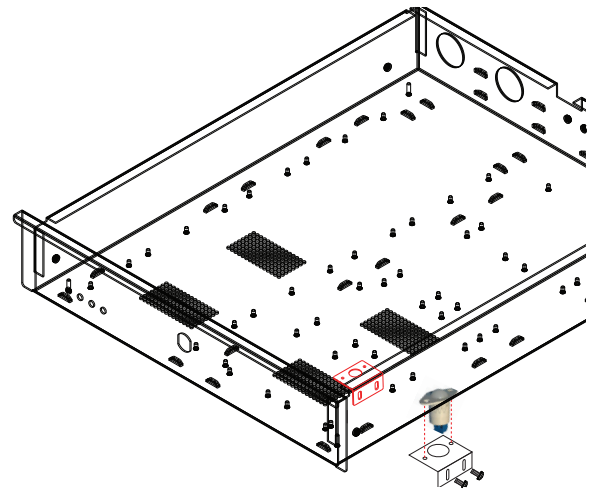
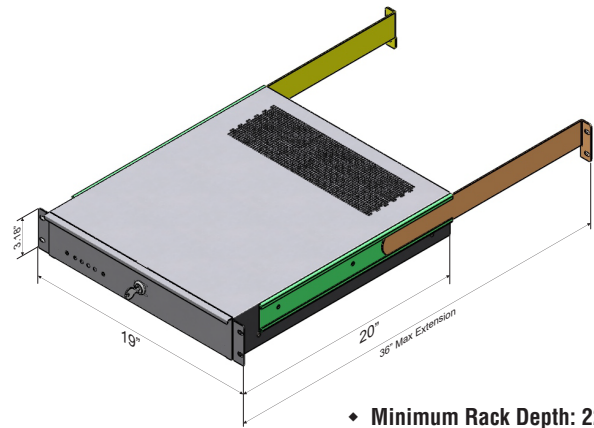
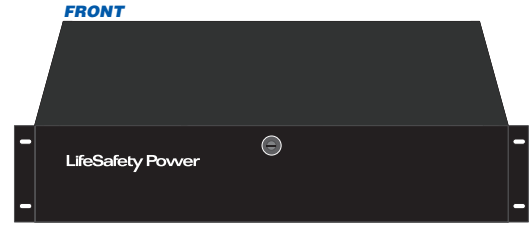
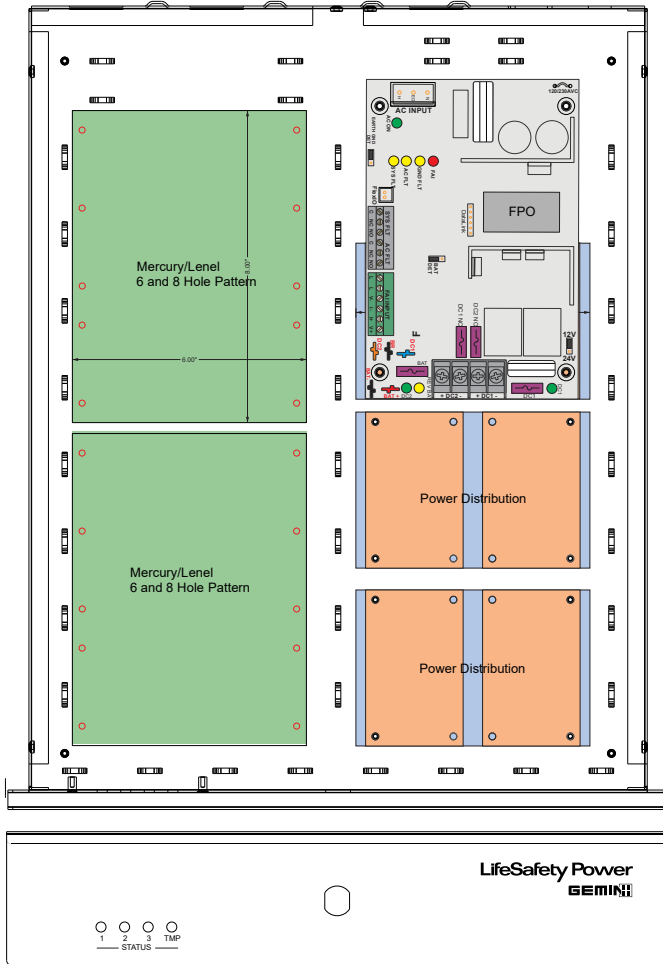
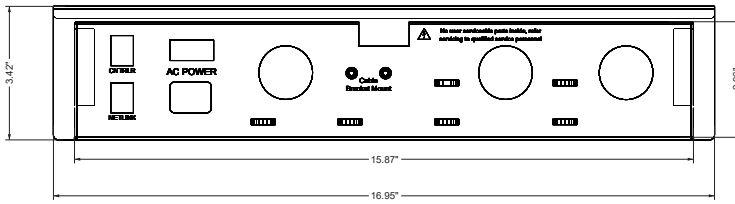

lifesafetypower.com

(888) 577-2898
 info1@lifesafetypower.com

Specifications subject to change without notice.

© 2022 LifeSafety Power. All rights reserved.
 LifeSafety Power and FlexPower are registered trademarks of LifeSafety Power.
 Mercury Security is a registered trademark of Mercury Security.
 P01-866A 07/22

LifeSafety Power
 10027 S. 51st Street, Suite 102
 Phoenix, AZ 85044 USA

Included Tamper Switch