

LifeSafety Power®

2024

ACCESS POWER GUIDE

FLEXPOWER Sets a New Standard of Performance

with industry leading features, standard on every power supply



Network Interface Option

Power supply programming, remote monitoring, reporting, and control

Smart Charger

Recharges batteries 50% faster
Monitors charge to prolong battery life

12/24V Select

TruWatt® design
Double current 12V setting

Field selectable input range

120VAC or 208-230VAC

OutSmart™

Color changing output LED
Visual voltage verification
blue 24V | green 12V

Polarized AC Disconnect

Safety feature for field servicing

Multiple DC Outputs

with TruWatt® power that follows Ohms Law

Standard Fuses

ATM style, easy to find and service

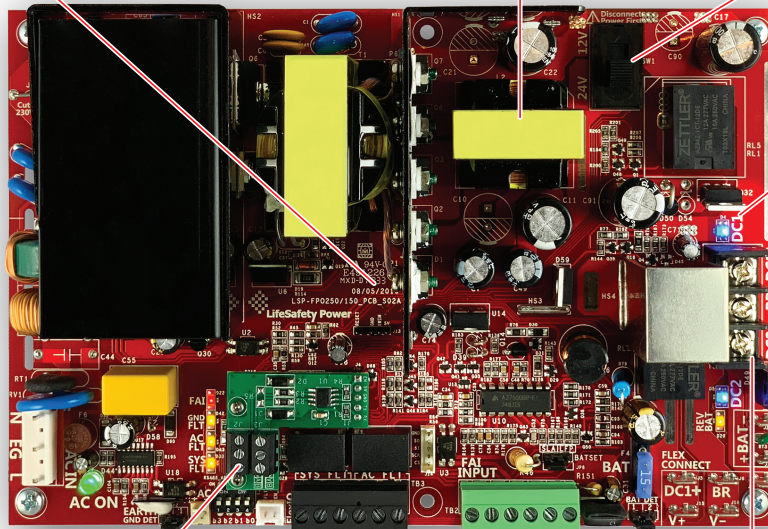

RS485 Communication

Remotely monitor up to 12 LSP power supplies through a single IP drop

Fault Reporting | Fire Alarm Interface

Programmable AC & system fault alert delays
Fire interface to unlock egress doors or operate door holders directly from the power supply

Output Control

Manage lock release through FAI drop
Reset outputs with network option



UL294, UL2610 | ULC S319 | CSA C22.2 #107.1 | FCC Part 15 | CSFM
IEC 62368-1:2014, EN55032:2015, EN61000-3-2:2014
EN61000-3-3:2013, EN55024:2010 +A1:2015
UL | CE | CSA | BIS | UKCA | NOM | RCM | PSE

Power Supplies

FPO | 120 208 230VAC

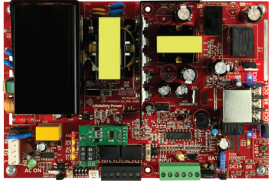

FPO150
FPO250



FPO75

12V DC



B100

FPG | Universal Input VAC

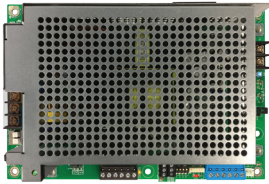

FPG100
FPG200



FPG50

Distribution Boards

Auxiliary

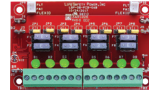

D8

Lock control



C4

Fire drop

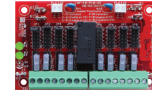

F8



D8P

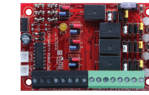

C4P

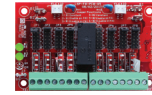

F8P

Lock control

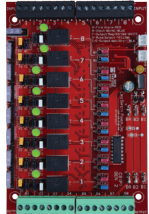

C8



C8P

Managed control



M8



M8P



SD16

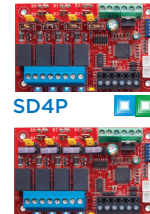

SD4

OUTSMART™ Visual Voltage Verification

Color changing output voltage LED confirms voltage setting

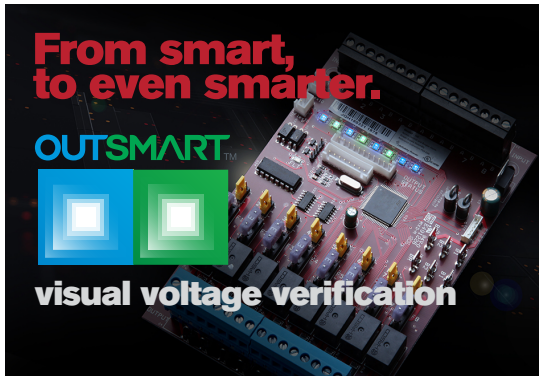

FLEXPOWER Unified Power Solutions®



FLEXPOWER
PART NUMBER DECODER

FPO XXX / XXX	XX CC DD MM	E X X	XX	/E <small>(for 230VAC)</small>
POWER SUPPLIES	ACCESSORY OPTIONS	ENCLOSURE	BACKPLATE	
<p>UL Series 120 or 230 VAC</p> <p>FPO75 75W 6A/12VDC or 3A/24VDC</p> <p>FPO150 150W 12A/12VDC or 6A/24VDC</p> <p>FPO250 250W 20A/12VDC or 10A/24VDC</p> <p><small>single voltage: FPO150 dual voltage: FPO150/250</small></p> <p>International Series 85-265 VAC</p> <p>FPG50 50W 2A/12VDC or 2A/24VDC</p> <p>FPG100 100W 8A/12VDC or 4A/24VDC</p> <p>FPG200 200W 8A/24VDC</p>	<p>B100 Secondary voltage, 5-18VDC @ 4A</p> <p>C4 Lock control distribution, 4 out</p> <p>C8 Lock control distribution, 8 out</p> <p>D8 Auxiliary distribution, 8 out</p> <p>F8 FAI distribution, 8 out</p> <p>M8 Managed lock control, 8 out (requires NL)</p> <p>SD4 Managed auxiliary, 4 out (requires NL)</p> <p>SD16 Managed auxiliary, 16 out (requires NL)</p> <p>NL4 Four port network module</p> <p>NLX Eight port network module w/ RS485</p>	<p>E5 8.5H" x 11W" x 3D"</p> <p>E1 14H" x 12W" x 4.5D"</p> <p>E2 20H" x 16W" x 4.5D"</p> <p>E4 24H" x 20W" x 6.5D"</p> <p>E6 30H" x 23W" x 6.5D"</p> <p>E8 36H" x 30W" x 6.5D"</p> <p>E12 48H" x 36W" x 8.0D"</p>	<p>A AMAG S SWH</p> <p>B BRIVO SP SIEMENS</p> <p>G GALLAGHER V HID AERO</p> <p>H HONEYWELL X AXIS</p> <p>M MERCURY Z ZKTECO</p> <p>P PAXTON</p> <p><small>"I" after letter for door mount (select backplates only)</small></p>	

For class II power limited add "P" to pn: C4P, C8P, D8P, F8P, M8P, SD4P
Note: SD16 is class II power limited and does not require a "P" in pn
Add number for multiple modules in system 3D8 2M8P 2B100



FPO150 / 250 - 3D8P 2M8 NL4 E8 M2

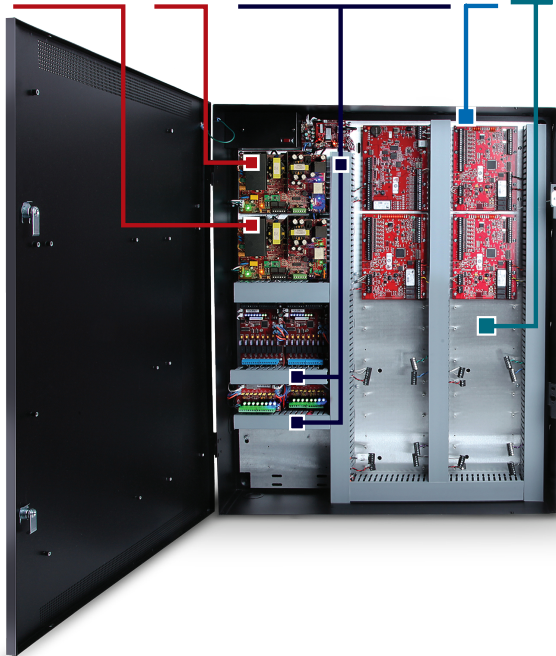

PART NUMBER KEY

Desired FPO power supply is inserted into the model number as "FPOxxx"

Multiple supplies are entered with a slash between variants i.e. FPO75/150

Multiples of the same accessory module are preceded by the quantity:

D8 = one D8 module for 8 outputs
 2D8 = two D8 modules for 16 outputs

EXAMPLE

FPO150 / 250 - 3D8P 2M8 NL4 E8M2

FPO150 - first power supply (typically 12V)
 FPO250 - second power supply (typically 24V)
 3 (three) D8P modules for 24 auxiliary outputs
 2 (two) M8 modules for 16 managed outputs
 NL4 Network module
 E8M2 - E8 (36 x 30 enclosure) with Mercury backplate



FlexPower is a modular system. This catalog contains a sample of popular configurations but many other models are possible. Visit www.LifeSafetyPower.com or contact the factory for options

Award Winning Power Supplies

Model Number	12VDC	24VDC	Total Power
FP075	6A	3A	75 Watts
FP0150	12A	6A	150 Watts
FP0250	20A	10A	250 Watts
B100	Secondary voltage power supply 5–18VDC output @4A max, class 2 power limited		

Industry Leading Features

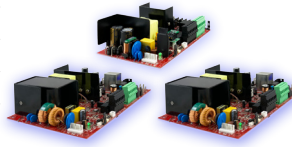

- US/Canada UL294/UL603 | CE compliant
- 110 / 208 / 230 VAC operation
- Switched and resettable outputs
- Intelligent battery charging and monitoring
- Complete fault supervision
- Thermal overload protection
- **Network ready | Lifetime Warranty**

Smart Management Modules

NL4, NLX	Network modules: 4 port, 8 port with RS485
M8	8 managed relay lock outputs
SD4, SD16	4, 16 managed auxiliary outputs

Applications

remotely monitor PSU, remote battery test, cycle output, generate email / SNMP fault alerts
manage, monitor, and control 8 inputs, 8 relay controlled outputs, user programmable fault limits
manage, monitor and remote reset auxiliary outputs, user programmable fault limits

FlexPower Distribution Modules - Unique Dual Buss Architecture

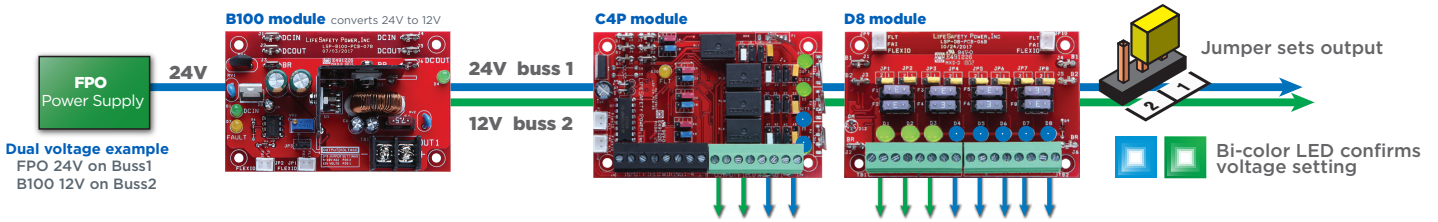

Lock Control Modules - Dual buss Distribution

Model	Outputs	Applications
C4	4 lock outputs	access control / 4 locks, field programmable
C8	8 lock outputs	access control / 8 locks, field programmable
F8	8 fire drop outputs	auxiliary power or fire drop per output with failsafe, failsecure select, field programmable

For Class 2 power limited version order C4P, C8P, F8P

Auxiliary Output Modules - Dual buss Distribution

Model	Outputs	Features
D8	8 DC outputs	auxiliary power or fire drop select per output, 12 or 24V DC per output (in dual voltage systems)
A8	8 AC outputs	24 or 28V AC select per output, field programmable

For Class 2 power limited version order D8P, A8P

Traditional Enclosures

Model	H x W x D	Description
E1	14 x 12 x 4.5 in.	good for single voltage with <i>some</i> room for accessory modules
E2	20 x 16 x 4.5 in.	good for single/dual voltage with <i>more</i> room for accessory modules
E4	24 x 20 x 6.5 in.	good for single/dual voltage with <i>most</i> room for accessory modules
E5	8.5 x 11 x 3.0 in.	good for single voltage with <i>least</i> room for accessory modules

Unified Power Enclosures / Backplates

Model	H x W x D	Backplate integrates power modules and controller from the following access companies
E5 M	8.5 x 11 x 3.0 in.	1DR Mercury PoE controller
E1 M/V	14 x 12 x 4.5 in.	1-2DR Mercury, Vertx/Aero
E2 K/H/M/P/S/V/X E2M1	20 x 16 x 4.5 in.	2-4DR Kantech, Honeywell, Mercury, Paxton, Software House, Vertx/Aero, AXIS
E4 A/B/G/H/I/K/M/OP/P/S/V/X/ZK	24 x 20 x 6.5 in.	6DR Paxton 4-12DR Honeywell, ZKTeco 8DR Amag, Brivo, Gallagher, Identiv, Kantech, Mercury, Openpath, Software House, Vertx/Aero, AXIS
E4x1 H1/M1/V1	24 x 20 x 6.5 in.	12DR Honeywell 8-16DR Mercury, Vertx/Aero
E6 A/B/G/H/K/M/N/OP/P/SP/S/V/ZK E6x1 A1/M1/S1	30 x 23 x 6.5 in.	8-16DR Amag, Brivo, Gallagher, Honeywell, Kantech, Mercury, Napco, Openpath, Paxton, Siemens, Software House, Vertx/Aero, ZKTeco
E8 A/B/G/H/M/P/SP/S/V	36 x 30 x 6.5 in.	12DR Honeywell, Mercury 16DR Amag, Brivo, Gallagher, Napco, Paxton, Siemens, SWH, Vertx/Aero
E8x1 B1/H1/M1	36 x 30 x 6.5 in.	12-16DR Brivo, Honeywell, Mercury
E8 M2	36 x 30 x 6.5 in.	16DR Mercury
E12 H/M/S	48 x 36 x 8.0 in.	24DR Honeywell, Mercury 32DR Software House

Traditional Enclosures



Relative Enclosure Sizes



Unified Power Enclosures

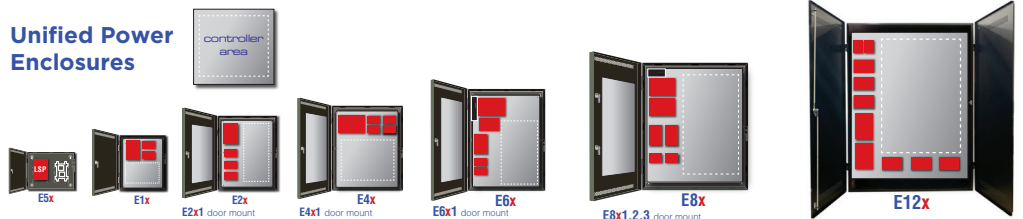

Industry Cross - Power	4A Power	4A Lock Power	6A Power	6A Lock Power
	FPO75-E1	FPO75-C8E1	FPO150-E1	FPO150-C8E1
Altronix ALX	AL400ULX	AL400ULACM	AL600ULX	AL600ULACM
Altronix eFLOW	eFLOW4N	eFLOW4N ACM8	eFLOW6N, eFLOW102N	eFLOW6N ACM8
Honeywell Power	HP400ULX	HP400ULACM8	HP600ULX	HP600ULACM8

Industry Cross - Outputs

LSP FlexPower	FlexPower Rating	Altronix
---------------	------------------	----------

8 lock outputs

FPO75-C8E1	6A/12V or 3A/24V	AL400ULACM
FPO150-C8E1	12A/12V or 6A/24V	AL600ULACM, AL1012ULACM
FPO250-C8E2	20A/12V or 10A/24V	AL400ULACM

8 or 16 distributed outputs

FPO75-D8E1	FPO75-2D8E1	6A/12V or 3A/24V	AL400ULXPD4,8	AL400ULXPD16
FPO150-D8E1	FPO150-2D8E1	12A/12V or 6A/24V	AL600ULXPD4,8	AL600ULXPD16
FPO250-D8E1	FPO250-2D8E1	20A/12V or 10A/24V	AL1024ULXPD4,8	AL1024ULXPD16

LSP Traditional Power Systems

Model	Power	Current / Voltage	Main Outputs		Description	Enclosure
			Switched	Continuous		
<i>Small Enclosure</i>						
FPO75-E1	75W	6A/12V or 3A/24V	1	1	75W Power Supply / Enclosure	14H x 12W x 4.5D
FPO150-E1	150W	12A/12V or 6A/24V	1	1	150W Power Supply / Enclosure	14H x 12W x 4.5D
FPO250-E1	250W	20A/12V or 10A/24V	1	1	250W Power Supply / Enclosure	14H x 12W x 4.5D
<i>Medium Enclosure</i>						
FPO75-E2	75W	6A/12V or 3A/24V	1	1	75W Power Supply / Enclosure	20H x 16W x 4.5D
FPO150-E2	150W	12A/12V or 6A/24V	1	1	150W Power Supply / Enclosure	20H x 16W x 4.5D
FPO250-E2	250W	20A/12V or 10A/24V	1	1	250W Power Supply / Enclosure	20H x 16W x 4.5D
<i>Large Enclosure</i>						
FPO75-E4	75W	6A/12V or 3A/24V	1	1	75W Power Supply / Enclosure	24H x 20W x 6.5D
FPO150-E4	150W	12A/12V or 6A/24V	1	1	150W Power Supply / Enclosure	24H x 20W x 6.5D
FPO250-E4	250W	20A/12V or 10A/24V	1	1	250W Power Supply / Enclosure	24H x 20W x 6.5D

System Power



Access Lock Power

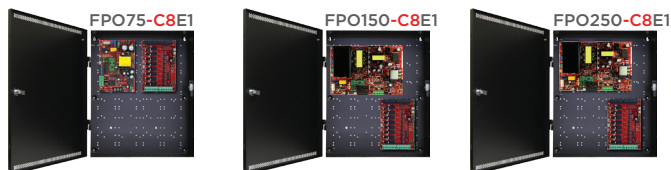

Power Enclosures

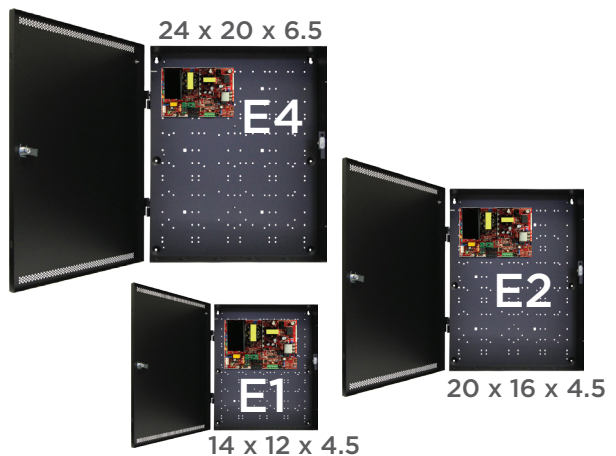

Single Voltage, 8 and 16 Outputs

Model	Power	Current / Voltage	Main Outputs		Description	E1 Enclosure
			Main	Aux		
8 Outputs						
FPO75-D8E1	75W	6A/12V or 3A/24V	2	8	75W, 8 auxiliary outputs	14H x 12W x 4.5D
FPO150-D8E1	150W	12A/12V or 10A/24V	2	8	150W, 8 auxiliary outputs	14H x 12W x 4.5D
FPO250-D8E1	250W	20A/12V or 10A/24V	2	8	250W, 8 auxiliary outputs	14H x 12W x 4.5D
16 Outputs						
FPO150-2D8E1	150W	12A/12V or 10A/24V	2	16	150W, 16 auxiliary outputs	14H x 12W x 4.5D
FPO250-2D8E1	250W	20A/12V or 10A/24V	2	16	250W, 16 auxiliary outputs	14H x 12W x 4.5D

For Class 2 power limited outputs order as D8P, 2D8P

Eight Outputs



Sixteen Outputs



Dual Voltage, 8 and 16 Outputs

Model	Power	Current / Voltage	Main Outputs		Description	E2 Enclosure
			Main	Aux		
8 Outputs						
FPO75/75-D8E2	150W	6A/12V & 3A/24V	4	8	150W, 8 auxiliary outputs	20H x 16W x 4.5D
FPO75/150-D8E2	225W	6A/12V & 6A/24V	4	8	225W, 8 auxiliary outputs	20H x 16W x 4.5D
FPO150/250-D8E2	400W	12A/12V & 10A/24V	4	8	400W, 8 auxiliary outputs	20H x 16W x 4.5D
FPO250/250-D8E2	500W	20A/12V & 10A/24V	4	8	500W, 8 auxiliary outputs	20H x 16W x 4.5D
16 Outputs						
FPO75/75-2D8E2	150W	6A/12V & 3A/24V	4	16	150W, 8 auxiliary outputs	20H x 16W x 4.5D
FPO150/250-2D8E2	400W	12A/12V & 10A/24V	4	16	400W, 8 auxiliary outputs	20H x 16W x 4.5D
FPO250/250-2D8E2	500W	20A/12V & 10A/24V	4	16	500W, 8 auxiliary outputs	20H x 16W x 4.5D

For Class 2 power limited outputs order as D8P, 2D8P

Dual Voltage Single Battery FPO/B100 Systems

Model	Power	Current / Voltage	Main Outputs		Description	Enclosure
			Switched	Continuous		
FPO75-B100E1	75W	2A/12V & 2A/24V	2	2	75W, Economical 12V&24V	12H x 14W x 4.5D
FPO150-B100E1	150W	4A/12V & 4A/24V	2	2	150W, Economical 12V&24V	12H x 14W x 4.5D

12 and 24V



12 and 24V with 8 auxiliary outputs

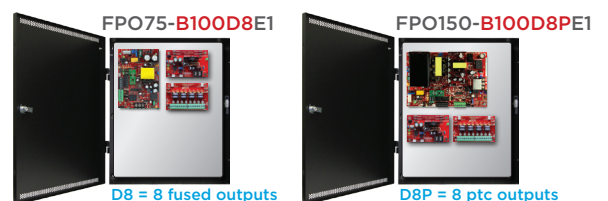

2A/12V 2A/24V

4A/12V 4A/24V

4A/12V 8A/24V

D8 = 8 fused outputs

D8P = 8 ptc outputs

Single Voltage, Lock Control

Model	Power	Current / Voltage	Main Outputs		Description	Enclosure
			Main	Lock		
<i>8 outputs</i>						
FPO75-C8E2	75W	6A/12V or 3A/24V	2	8	75W, 8 lock outputs	20H x 16W x 4.5D
FPO150-C8E2	150W	12A/12V or 6A/24V	2	8	150W, 8 lock outputs	20H x 16W x 4.5D
FPO250-C8E2	250W	20A/12V or 10A/24V	2	8	250W, 8 lock outputs	20H x 16W x 4.5D
<i>16 outputs</i>						
FPO75-2C8E2	75W	6A/12V or 3A/24V	2	16	75W, 16 lock outputs	20H x 16W x 4.5D
FPO150-2C8E2	150W	12A/12V or 6A/24V	2	16	150W, 16 lock outputs	20H x 16W x 4.5D
FPO250-2C8E2	250W	20A/12V or 10A/24V	2	16	250W, 16 lock outputs	20H x 16W x 4.5D

For Class 2 power limited outputs order as -C8PE2, -2C8PE2

Dual Voltage, Lock Control

Model	Power	Current / Voltage	Main Outputs		Description	Enclosure
			Main	Lock		
<i>16 outputs</i>						
FPO75/250-2C8E2	225W	6A/12V or 3A/24V & 12A/12V or 6A/24V	4	16	225W, 16 lock outputs	20H x 16W x 4.5D
FPO150/250-2C8E2	400W	12A/12V or 6A/24V & 20A/12V or 10A/24V	4	16	400W, 16 lock outputs	20H x 16W x 4.5D

For Class 2 power limited outputs order as -2C8PE2

Single Voltage, FAI Control

Model	Power	Current / Voltage	Main Outputs		Description	Enclosure
			Main	FAI		
<i>8 outputs</i>						
FPO75-F8E1	75W	6A/12V or 3A/24V	2	8	75W, 8 egress control outputs	14H x 12W x 4.5D
FPO150-F8E1	150W	12A/12V or 6A/24V	2	8	150W, 8 egress control outputs	14H x 12W x 4.5D
FPO250-F8E1	250W	20A/12V or 10A/24V	2	8	250W, 8 egress control outputs	14H x 12W x 4.5D
FPO250-2F8E2	250W	20A/12V or 10A/24V	2	16	250W, 16 egress control outputs	20H x 16W x 4.5D

For Class 2 power limited outputs order as -F8PE1, -2F8PE2

C8 door lock control

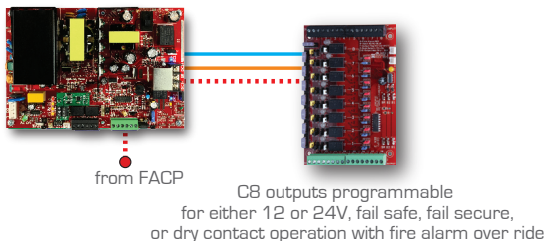

F8 door egress with access control system

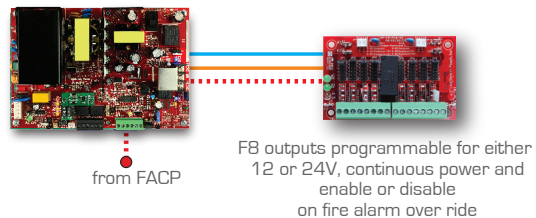

Dual Voltage, Expandable Systems

Model	Max Power	Current / Voltage	Main Outputs		Distribution Expansion	E2 Enclosure
			Switched	Continuous		
<i>E2 Expandable System</i>						
FPO75/75-E2	150W	6A/12V & 3A/24V	2	2	Up to 48 Outputs	20H x 16W x 4.5D
FPO75/150-E2	225W	6A/12V & 6A/24V	2	2	Up to 48 Outputs	20H x 16W x 4.5D
FPO150/250-E2	400W	12A/12V & 10A/24V	2	2	Up to 48 Outputs	20H x 16W x 4.5D
FPO250/250-E2	500W	20A/12V & 10A/24V	2	2	Up to 48 Outputs	20H x 16W x 4.5D
<i>E4 Expandable System</i>						
FPO75/75-E4	150W	6A/12V & 3A/24V	2	2	Up to 128 Outputs	24H x 20W x 6.5D
FPO75/150-E4	225W	6A/12V & 6A/24V	2	2	Up to 128 Outputs	24H x 20W x 6.5D
FPO150/250-E4	400W	12A/12V & 10A/24V	2	2	Up to 128 Outputs	24H x 20W x 6.5D
FPO250/250-E4	500W	20A/12V & 10A/24V	2	2	Up to 128 Outputs	24H x 20W x 6.5D

E2 Expansion



E4 Expansion



Expansion Options

- MULTI VOLTAGE
- LOCK/EGRESS CONTROL
- AUXILIARY DISTRIBUTION
- NETWORK MONITORING

B100



C4



C8



D8



F8

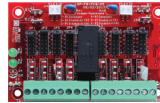

NL4



M8



SD16

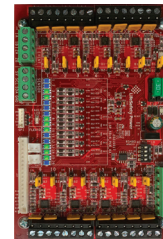

NLX



SD4



4 Door Single Voltage, Access Control

Model	Power	Current / Voltage	Main Outputs		Description	Enclosure
			Lock	Aux		
<i>4 lock outputs</i>						
FPO75-C4E1	75W	6A/12V or 3A/24V	4		75W, 4 lock outputs	14H x 12W x 4.5D
FPO150-C4E1	150W	12A/12V or 6A/24V	4		150W, 4 lock outputs	14H x 12W x 4.5D
FPO250-C4E1	250W	20A/12V or 10A/24V	4		250W, 4 lock outputs	14H x 12W x 4.5D
<i>4 lock and 8 auxiliary outputs</i>						
FPO75-C4D8E1	75W	6A/12V or 3A/24V	4	8	75W, 4 lock, 8 aux outputs	14H x 12W x 4.5D
FPO150-C4D8E1	150W	12A/12V or 6A/24V	4	8	150W, 4 lock, 8 aux outputs	14H x 12W x 4.5D
FPO250-C4D8E1	250W	20A/12V or 10A/24V	4	8	250W, 4 lock, 8 aux outputs	14H x 12W x 4.5D

For Class 2 power limited outputs order as -C4PE1, -C4PD8PE1. Note: "C4D8E1" configurations may require battery mounted in sideways

4 Door Dual Voltage, Access Control

Model	Power	Current / Voltage	Main Outputs		Description	Enclosure
			Lock	Aux		
<i>4 lock and 8 auxiliary outputs</i>						
FPO75/75-C4D8E2	150W	6A/12V or 3A/24V (X2)	4	8	150W, 4 lock, 8 aux outputs	20H x 16W x 4.5D
FPO75/150-C4D8E2	225W	6A/12V or 3A/24V & 12A/12V or 6A/24V	4	8	225W 4 lock, 8 aux outputs	20H x 16W x 4.5D
FPO250/250-C4D8E2	400W	12A/12V or 6A/24V & 20A/12V or 10A/24V	4	8	400W, 4 lock, 8 aux outputs	20H x 16W x 4.5D
<i>4 lock and 8 auxiliary outputs (single battery set)</i>						
FPO75-B100C4D8E2	75W	2A/12V and 2A/24V	4	8	75W, 4 lock, 8 aux outputs	20H x 16W x 4.5D
FPO150-B100C4D8E2	150W	4A/12V and 4A/24V	4	8	150W, 4 lock, 8 aux outputs	20H x 16W x 4.5D
FPO250-B100C4D8E2	250W	4A/12V and 8A/24V	4	8	250W, 4 lock, 8 aux outputs	20H x 16W x 4.5D

For Class 2 power limited outputs order as -C4PD8PE2

4 Door Dual Voltage

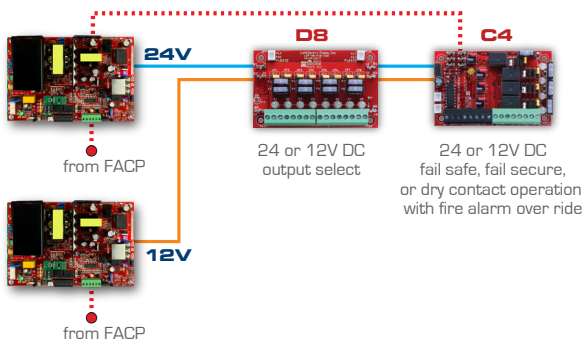

4 Door Dual Voltage - single battery

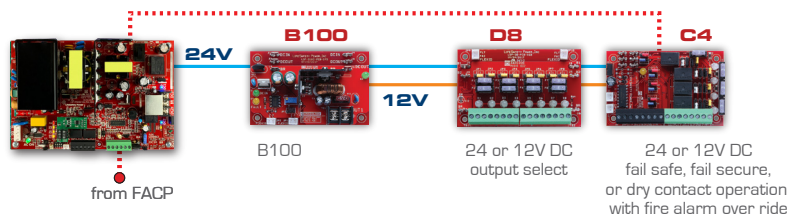

8 Door Single / Dual Voltage, Access Control

Model	Power	Current / Voltage	Main Outputs		Description	Enclosure
			Lock	Aux		
<i>Single Voltage - 8 lock and auxiliary outputs</i>						
FPO75-C8D8E1	75W	6A/12V or 3A/24V	8	8	75W, 8 lock, 8 aux outputs	14H x 12W x 4.5D
FPO150-C8D8E2	150W	12A/12V or 6A/24V	8	8	150W, 8 lock, 8 aux outputs	20H x 16W x 4.5D
FPO250-C8D8E2	250W	20A/12V or 10A/24V	8	8	250W, 8 lock, 8 aux outputs	20H x 16W x 4.5D
<i>Dual Voltage - 8 lock and auxiliary outputs</i>						
FPO75/75-C8D8E2	150W	6A/12V or 3A/24V (X2)	8	8	150W DV, 8 lock, 8 aux outputs	20H x 16W x 4.5D
FPO75/150-C8D8E2	225W	6A/12V or 3A/24V & 12A/12V or 6A/24V	8	8	225W DV, 8 lock, 8 aux outputs	20H x 16W x 4.5D
FPO150/150-C8D8E2	300W	12A/12V or 6A/24V (X2)	8	8	300W DV, 8 lock, 8 aux outputs	20H x 16W x 4.5D
<i>Dual Voltage (single battery) - 8 lock and auxiliary outputs</i>						
FPO150-B100C8D8E2	150W	4A/12V and 4A/24V	8	8	150W DV, 8 lock, 8 aux outputs	20H x 16W x 4.5D
FPO250-B100C8D8E2	250W	4A/12V and 8A/24V	8	8	250W DV, 8 lock, 8 aux outputs	20H x 16W x 4.5D

For Class 2 power limited outputs order model with "C8PD8P" suffix

16 Door Single / Dual Voltage, Access Control

Model	Power	Current / Voltage	Main Outputs		Description	Enclosure
			Lock	Aux		
<i>Single Voltage - 16 lock and auxiliary outputs</i>						
FPO150-2C82D8E4	150W	12A/12V or 6A/24V	16	16	150W, 16 lock, 16 aux outputs	24H x 20W x 6.5D
FPO250-2C82D8E4	250W	20A/12V or 10A/24V	16	16	250W, 16 lock, 16 aux outputs	24H x 20W x 6.5D
<i>Dual Voltage - 16 lock and auxiliary outputs</i>						
FPO75/150-2C82D8E4	225W	6A/12V or 3A/24V & 12A/12V or 6A/24V	16	16	225W DV, 16 lock, 16 aux outputs	24H x 20W x 6.5D
FPO150/150-2C82D8E4	300W	12A/12V or 6A/24V (X2)	16	16	300W DV, 16 lock, 16 aux outputs	24H x 20W x 6.5D
FPO150/250-2C82D8E4	400W	12A/12V or 6A/24V & 20A/12V or 10A/24V	16	16	400W DV, 16 lock, 16 aux outputs	24H x 20W x 6.5D
<i>Dual Voltage (single battery) - 16 lock and auxiliary outputs</i>						
FPO250-B1002C82D8E4	250W	4A/12V and 8A/24V	16	16	250W DV, 16 lock, 16 aux outputs	24H x 20W x 6.5D

For Class 2 power limited outputs order model with "2C8P2D8P" suffix

Award winning **FlexPower Unified Power Solutions**
 Integrated access power

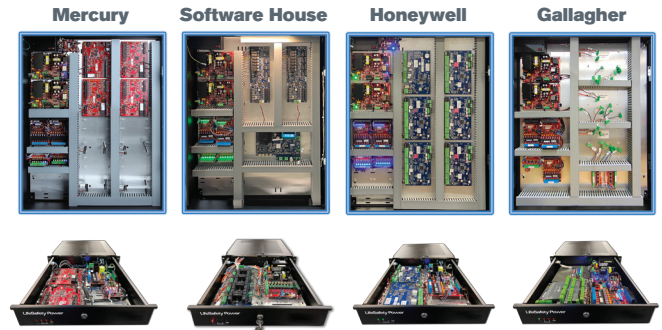

The Power of ONE

Unified Power Solutions are award-winning power management systems that bring access hardware, system power, lock power and optional network management modules together in a single, optimized wall enclosure.

Unified Power systems integrate directly to the controller products of leading access manufacturers, offering substantial savings in installation time and labor.

Pre-engineered - FlexPower products are designed in partnership with industry leading access manufacturers including Mercury Security, AMAG, Software House, HID, Honeywell, Brivo and Paxton.

Seamless design - All units feature the mechanical integration of lock and system power, alongside access panel hardware into a single, UL-listed, access power management system.

Labor savings - A single enclosure with one AC drop, removable backplate and a flexible mix-and-match mounting pattern significantly reduces field installation times and errors.

Innovative architecture - The system's unique dual-buss structure distributes 12 and 24VDC to all accessory modules with bi-color LED voltage indicators, so system and lock power are always available on a user-select basis.

Traditional Access Power

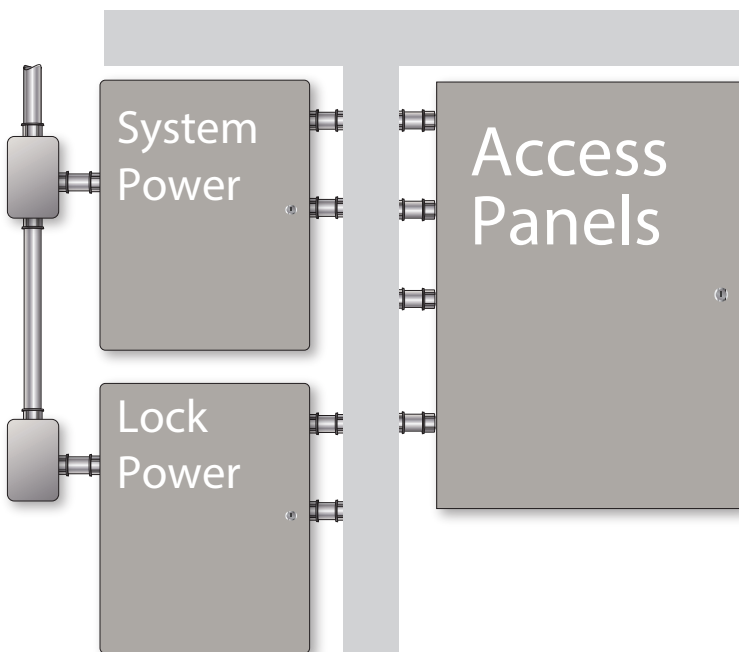



Installation and service efficiencies

One AC drop reduces installation costs
 Removable backplate simplifies access panel wiring and minimizes installation time and labor costs
 Deep enclosures accommodate large battery sets

Pre-wired power section saves installation time

120 or 230VAC input with safe AC disconnect circuit breaker switch

Custom mounting access backplate

Enclosure options support four, eight, or sixteen door access control systems with dual voltage and remote networking

Network management option

Enables remote servicing
 Live monitoring of system parameters
 Initiate remote battery load tests or remote power cycle connected devices



Unified Power systems are UL/ULC certified with a Lifetime Warranty and mix and match compatible for maximum design flexibility

Managed Unified Power - the heart of a healthy access system

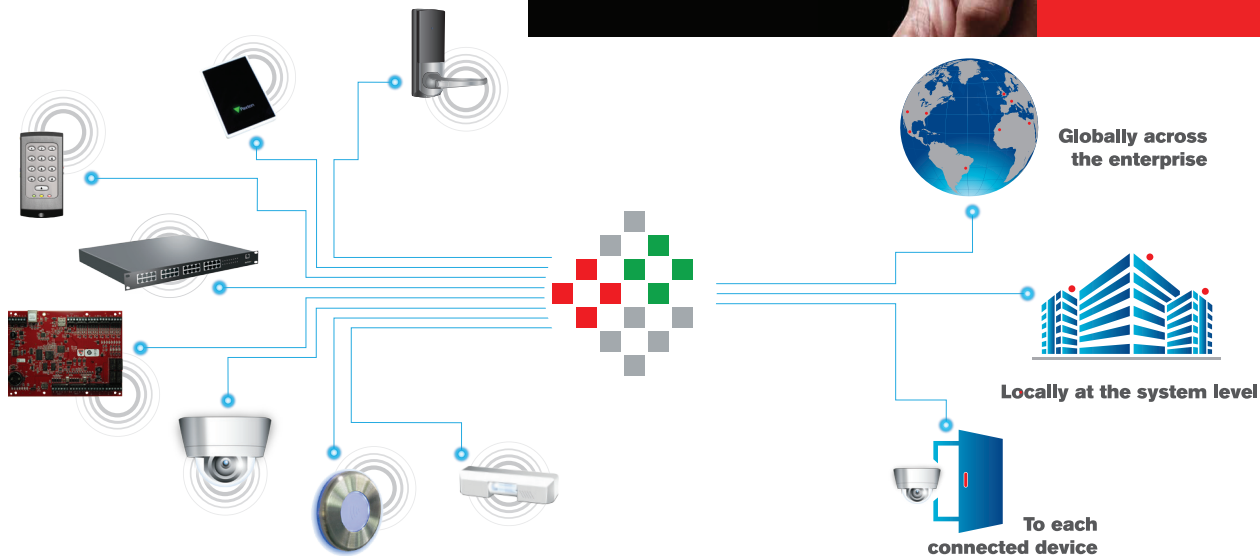

UNIFIEDPOWER

Mercury | Two, Four, Eight Door Configurations

Dual V	STANDARD	MANAGED	12VDC	24VDC	ENCLOSURE	POWER and PANEL MOUNTING
2DR	FPO75-B100C4PE2M	FPO75-B100M8PNL4E2M	2A	2A	20 x 16 x 4.5	System power, lock power / two max Mercury
4DR	FPO75-B100C4PD8PE2M	FPO75-B100M8PNL4E2M	2A	2A	20 x 16 x 4.5	System power, lock power / two max Mercury
4DR	FPO75-B100C8PD8PE4M	FPO75-B100M8PNL4E4M	2A	2A	24 x 20 x 6.5	System power, lock power / four max Mercury
8DR	FPO150-B100C8PD8PE4M	FPO150-B100D8PM8PNL4E4M	4A	4A	24 x 20 x 6.5	System power, lock power / four max Mercury
8DR	FPO150-B100C8PD8PE6M	FPO150-B100D8PM8PNL4E6M	4A	4A	30 x 23 x 6.5	System power, lock power / four max Mercury
Single V						
2DR	FPO75-D8PE1M	FPO75-D8PNL4E1M	12V/6A, 24V/3A		14 x 12 x 4.5	System power / one max Mercury
4DR	FPO75-D8PE2M	FPO75-M8PNL4E2M	12V/6A, 24V/3A		20 x 16 x 4.5	System power / two max Mercury
4DR	FPO75-D8PE4M	FPO75-M8PNL4E4M	12V/6A, 24V/3A		24 x 20 x 6.5	System power / four max Mercury
8DR	FPO150-D8PE4M	FPO150-M8PNL4E4M	12V/12A, 24V/6A		24 x 20 x 6.5	System power / four max Mercury
8DR	FPO150-D8PE6M	FPO150-M8PNL4E6M	12V/12A, 24V/6A		30 x 23 x 6.5	System power / four max Mercury

System part number can be modified to change output protection Fused outputs = C4, C8, D8, M8 | Class II power limited outputs = C4P, C8P, D8P, M8P

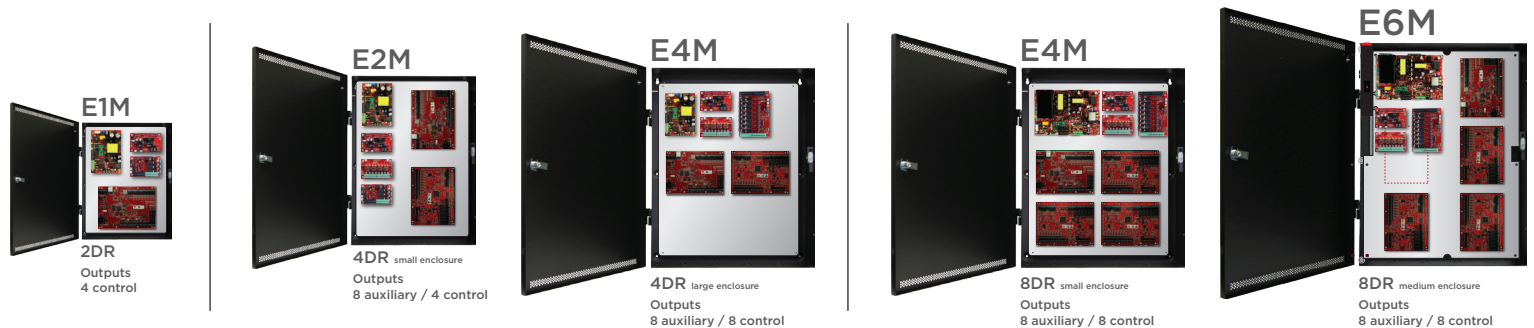
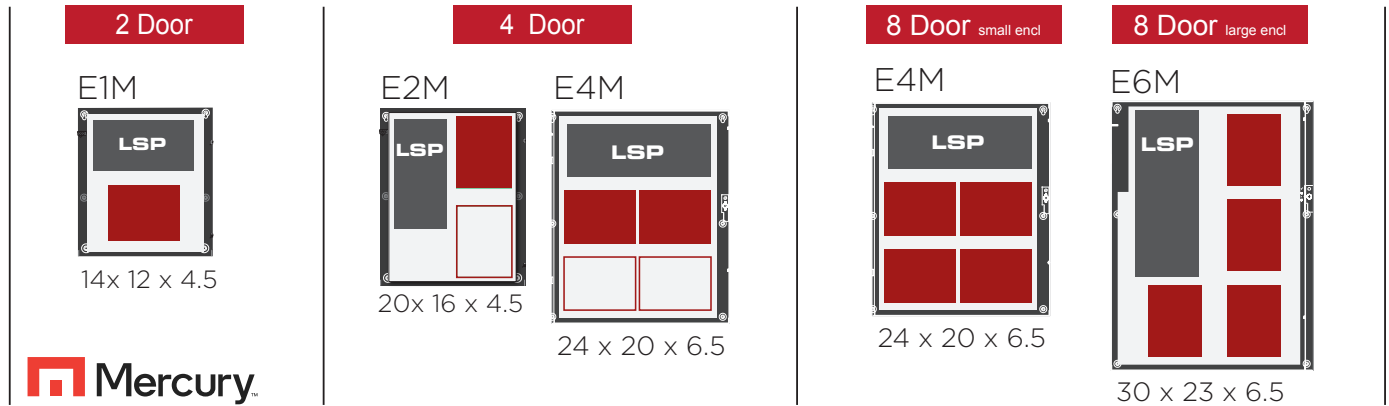

Part numbers in this product guide numbers are most common but many other configurations are possible. Contact Factory Technical Support or visit LSP Website for more information.

UNIFIEDPOWER

Mercury | Sixteen and Twenty Four Door Configurations

Dual V	STANDARD	MANAGED	12VDC	24VDC	ENCLOSURE	POWER and PANEL MOUNTING
16DR	FPO150/250-2C8P2D8PE6M1	FPO150/250-2D8P2M8PNL4E6M1	12A	10A	30 x 23 x 6.5	System power, lock power / eight max Mercury
16DR	FPO150/250-2C8P2D8PE8M1	FPO150/250-2D8P2M8PNL4E8M1	12A	10A	36 x 30 x 6.5	System power, lock power / eight max Mercury
16DR	FPO150/250-2C8P2D8PE8M2	FPO150/250-2D8P2M8PNL4E8M2	12A	10A	36 x 30 x 6.5	System power, lock power / eight max Mercury
24DR	FPO250/250-3C8P3D8PE12M	FPO250/250-3D8P3M8PNLXE12M	20A	10A	48 x 36 x 8.0	System power, lock power / twelve max Mercury
Single V						
16DR	FPO150-2D8PE6M1	FPO150-2M8PNL4E6M1	12V/12A, 24V/6A		30 x 23 x 6.5	System power / eight max Mercury
16DR	FPO150-2D8PE8M1	FPO150-2M8PNL4E8M1	12V/12A, 24V/6A		36 x 30 x 6.5	System power / eight max Mercury
16DR	FPO150-2D8PE8M2	FPO150-2M8PNL4E8M2	12V/12A, 24V/6A		36 x 30 x 6.5	System power / eight max Mercury
24DR	FPO250-3D8PE12M	FPO250-3M8PNL4E12M	12V/20A, 24V/10A		48 x 36 x 8.0	System power / twelve max Mercury

System part number can be modified to change output protection Fused outputs = C4, C8, D8, M8 | Class II power limited outputs = C4P, C8P, D8P, M8P

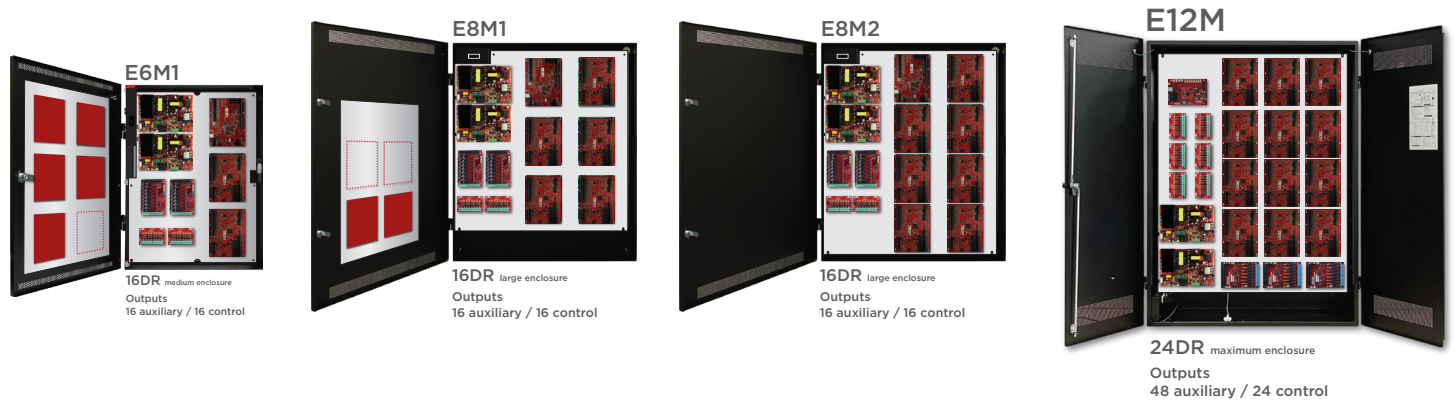
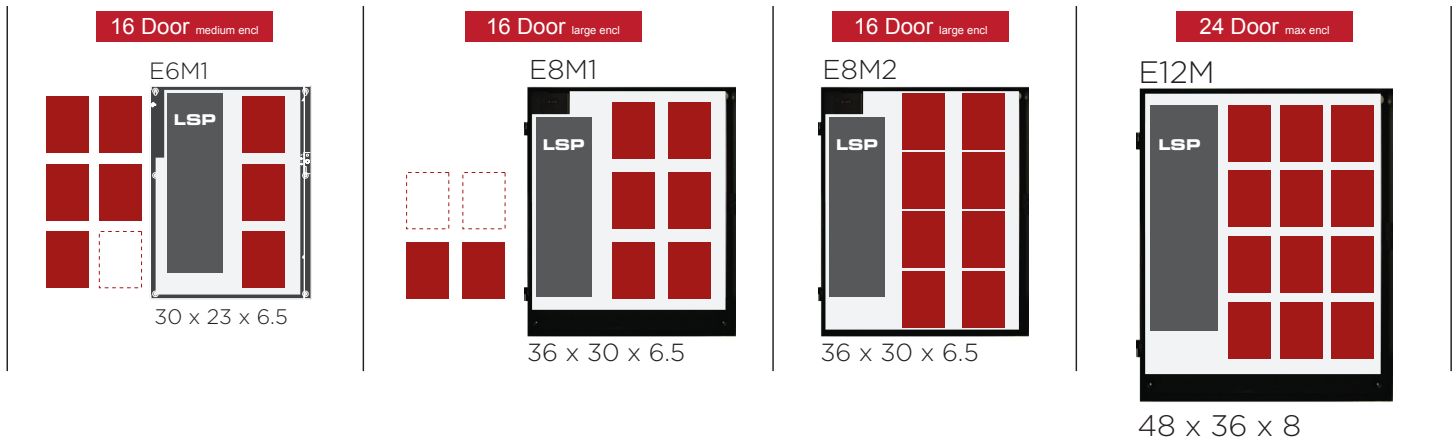

Part numbers in this product guide numbers are most common but many other configurations are possible. Contact Factory Technical Support or visit LSP Website for more information.

UNIFIEDPOWER

Software House | Four, Eight and Sixteen Door Configurations

DOORS	STANDARD PN	MANAGED PN	12VDC	24VDC	ENCL H x W x D	PANEL MOUNTING
SWH						
4	FPO75-B100C8PD8PE4S	FPO75-B100M8PNL4E4S	2A	2A	24 x 20 x 6.5	GCM, ACM
8	FPO75/150-C8PD8PE4S	FPO75/150-D8PM8PNL4E4S	6A	6A	24 x 20 x 6.5	GCM, ACM
8	FPO75/150-C8PD8PE6S	FPO75/150-D8PM8PNL4E6S	6A	6A	30 x 23 x 6.5	GCM, ACM
16	FPO150/250-2D8PE6S	FPO150/250-2M8PNL4E6S	12A	10A	30 x 23 x 6.5	GCM, two ACM
16	FPO150/250-2C8P2D8PE8S	FPO150/250-2D8P2M8PNL4E8S	12A	10A	36 x 30 x 6.5	GCM, two ACM, IO

System part number can be modified to change output protection Fused outputs = C4, C8, D8, M8 | Class II power limited outputs = C4P, C8P, D8P, M8P

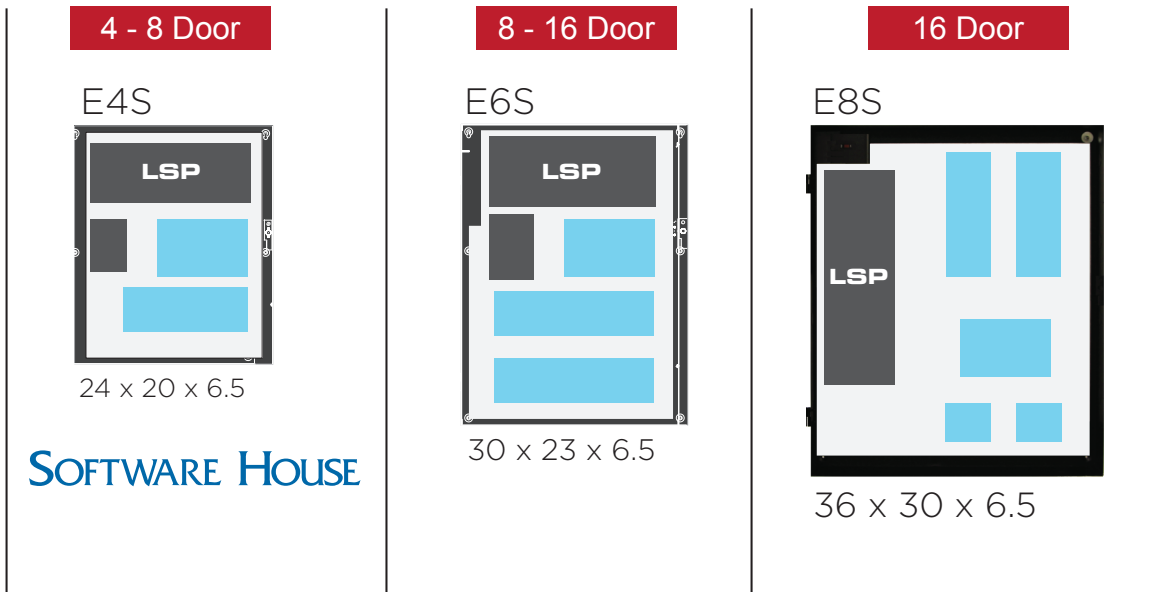

Part numbers in this product guide numbers are most common but many other configurations are possible.
 Contact Factory Technical Support or visit LSP Website for more information.

UNIFIEDPOWER

AMAG | Four, Eight and Sixteen Door Configurations

DOORS	STANDARD PN	MANAGED PN	12VDC	24VDC	ENCL H x W x D	POWER AND PANEL MOUNTING
AMAG						
4	FPO75-B100C4PD8PE4A	FPO75-B100M8PNL4E4A	2A	2A	24 x 20 x 6.5	System, lock power / one 4DBC or M4000
8	FPO150-B100C8PD8PE4A	FPO150-B100D8PM8PNL4E4A	4A	4A	24 x 20 x 6.5	System, lock power / one 8DBC or 2 M4000
8	FPO150-B100C8PD8PE6A	FPO150-B100D8PM8PNL4E6A	4A	4A	30 x 23 x 6.5	System, lock power / one 8DBC or 2 M4000
16	FPO150/250-2C8P2D8PE8A	FPO150/250-2D8P2M8PNL4E8A	12A	10A	36 x 30 x 6.5	System, lock power / two 8DBC or 4 M4000

System part number can be modified to change output protection Fused outputs = C4, C8, D8, M8 | Class II power limited outputs = C4P, C8P, D8P, M8P

4 - 8 Door

E4A
24 x 20 x 6.5

A G4S COMPANY

8 - 12 Door

E6A
30 x 23 x 6.5

16 Door

E8A
36 x 30 x 6.5

M4000
M4000

All enclosures have dual pattern

E4A
4DR
Outputs
8 auxiliary / 4 control

E4A
8DR small enclosure
Outputs
8 auxiliary / 8 control

E6A
8DR medium enclosure
Outputs
8 auxiliary / 8 control

E8A
16DR
Outputs
16 auxiliary / 16 control

Part numbers in this product guide numbers are most common but many other configurations are possible. Contact Factory Technical Support or visit LSP Website for more information.

UNIFIEDPOWER

ProWatch | Four, Eight Sixteen, 24 Door Configurations

DOORS	STANDARD PN	MANAGED PN	12VDC	24VDC	ENCL H x W x D	POWER AND PANEL MOUNTING
HONEYWELL						
4	FPO75-B100C4D8PE2H	FPO75-B100M8PNL4E2H	2A	2A	20 x 16 x 4.5	System power, lock power / two Prowatch
8	FPO150-B100C8D8PE4H1	FPO150-B100D8PM8NL4E4H1	4A	4A	24 x 20 x 6.0	System power, lock power / four Prowatch
16	FPO150/250-2C82D8PE8H1	FPO150/250-2D8P2M8NL4E8H1	12A	10A	36 x 30 x 6.5	System power, lock power / eight Prowatch
24	FPO250/250-3C83D8PE12H	FPO250/250-3D8P3M8NLXE12H	20A	20A	48 x 36 x 8.0	System power, lock power / twelve Prowatch

System part number can be modified to change output protection Fused outputs = C4, C8, D8, M8 | Class II power limited outputs = C4P, C8P, D8P, M8P

4 Door

8 Door

16 Door

24 Door

E2H

E4H1

E8H1

E12H

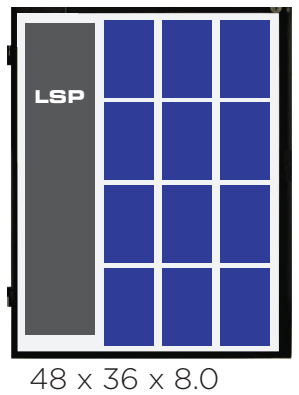
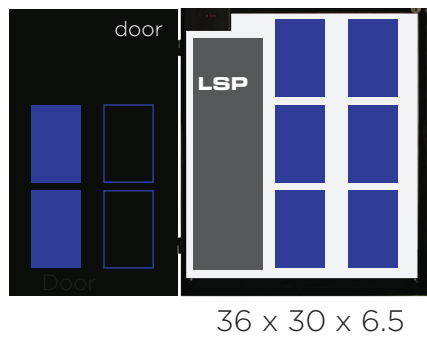
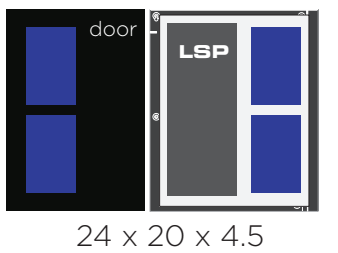
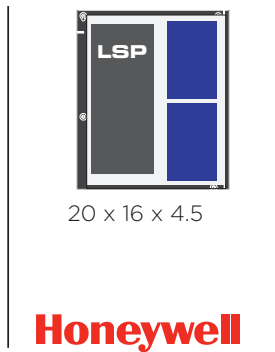

Honeywell

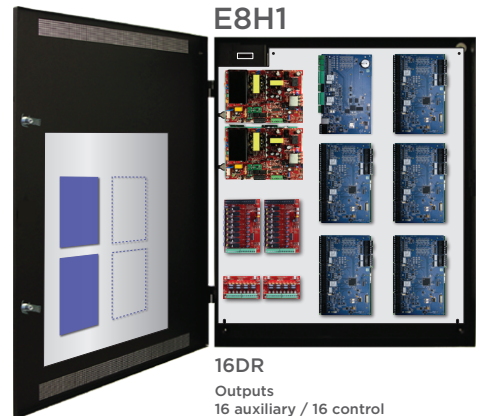
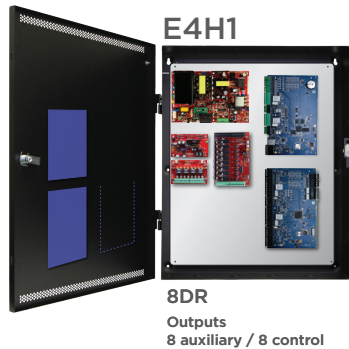
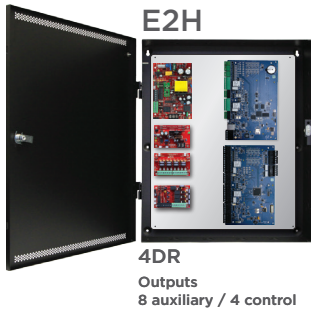

Part numbers in this product guide numbers are most common but many other configurations are possible. Contact Factory Technical Support or visit LSP Website for more information.

UNIFIEDPOWER

Vertx/Aero | Two, Four, Eight and Sixteen Door Configurations

DOORS	STANDARD PN	MANAGED PN	12VDC	24VDC	ENCL H x W x D	POWER AND PANEL MOUNTING
HID						
2	FPO75-B100C4PE2V	FPO75-B100M8PNL4E2V	2A	2A	20 x 16 x 4.5	System power, lock power / two Vertx
4	FPO75-B100C4PD8PE4V	FPO75-B100M8PNL4E4V	2A	2A	24 x 20 x 6.5	System power, lock power / three Vertx
8	FPO150-B100C8PD8PE4V1	FPO150-B100D8PM8PNL4E4V1	4A	4A	24 x 20 x 6.5	System power, lock power / six Vertx
8	FPO150-B100C8PD8PE6V	FPO150-B100D8PM8PNL4E6V	4A	4A	30 x 23 x 6.5	System power, lock power / four Vertx
16	FPO150/250-2C8P2D8PE6V1	FPO150/250-2D8P2M8PNL4E6V1	12A	10A	30 x 23 x 6.5	System power, lock power / nine Vertx
16	FPO150/250-2C8P2D8PE8V	FPO150/250-2D8P2M8PNL4E8V	12A	10A	36 x 30 x 6.5	System power, lock power / nine Vertx

System part number can be modified to change output protection Fused outputs = C4, C8, D8, M8 | Class II power limited outputs = C4P, C8P, D8P, M8P

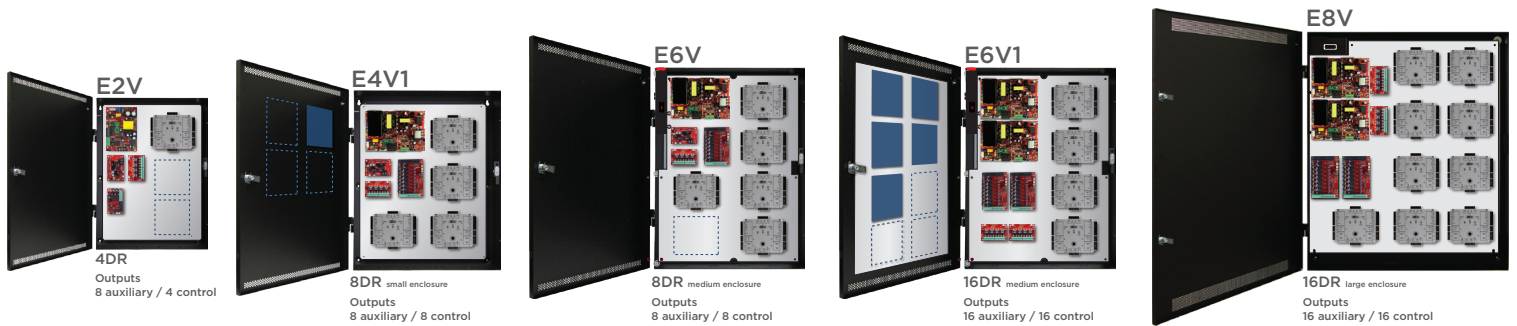
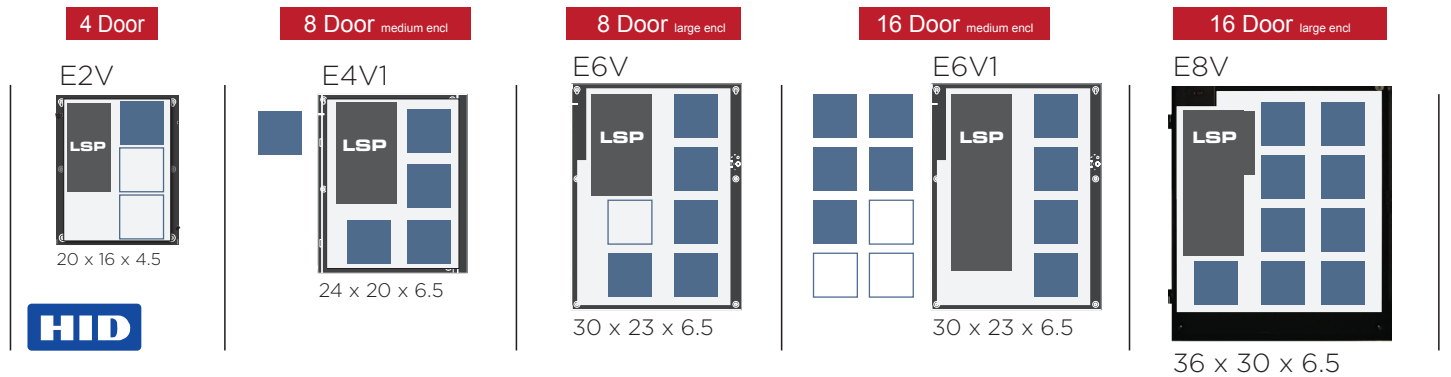

Part numbers in this product guide numbers are most common but many other configurations are possible. Contact Factory Technical Support or visit LSP Website for more information.

UNIFIEDPOWER

Brivo | Four, Eight and Sixteen Door Configurations

DOORS	STANDARD PN	MANAGED PN	12VDC	24VDC	ENCL H x W x D	POWER AND PANEL MOUNTING
BRIVO						
4	FPO150-B100C8D8PE4B	FPO150-B100D8PM8NL4E4B	4A	4A	24 x 20 x 6.5	System power, lock power / three Brivo
8	FPO150-B100C8D8PE6B	FPO150-B100D8PM8NL4E6B	4A	4A	30 x 23 x 6.5	System power, lock power / four Brivo
8	FPO150-B100C8D8PE8B	FPO150-B100D8PM8NL4E8B	4A	4A	36 x 30 x 6.5	System power, lock power / seven Brivo
16	FPO150/250-2C82D8PE6B1	FPO150/250-2D8P2M8NL4E6B1	12A	10A	30 x 23 x 6.5	System power, lock power / eight Brivo
16	FPO150/250-2C82D8PE8B1	FPO150/250-2D8P2M8NL4E8B1	12A	10A	36 x 30 x 6.5	System power, lock power / ten Brivo

System part number can be modified to change output protection Fused outputs = C4, C8, D8, M8 | Class II power limited outputs = C4P, C8P, D8P, M8P

4 Door

8 Door

8 - 16 Door

16 Door

E4B

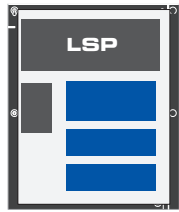

24 x 20 x 6.5

E6B

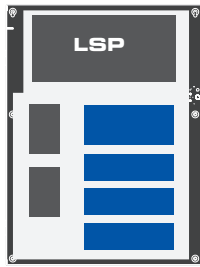

30 x 23 x 6.5

E6B

E6B1



30 x 23 x 6.5

E8B

E8B1

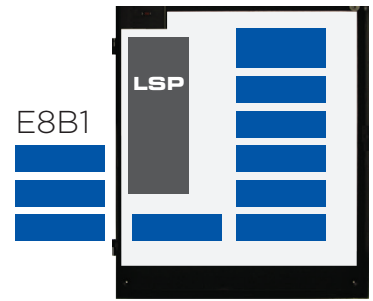

36 x 30 x 6.5

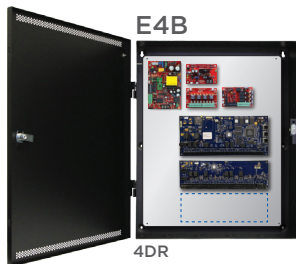

E4B

4DR
Outputs
8 auxiliary / 4 control

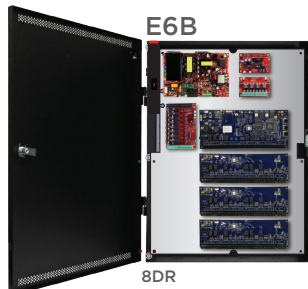

E6B

8DR
Outputs
8 auxiliary / 8 control



E6B1

16DR medium enclosure
Outputs
16 auxiliary / 16 control



E8B1

16DR large enclosure
Outputs
16 auxiliary / 16 control

Part numbers in this product guide numbers are most common but many other configurations are possible. Contact Factory Technical Support or visit LSP Website for more information.

UNIFIEDPOWER

Paxton | Four, Eight and Sixteen Door Configurations

DOORS	STANDARD PN	MANAGED PN	12VDC	24VDC	ENCL H x W x D	POWER AND PANEL MOUNTING
PAXTON						
4	FPO75-B100D8E2P	FPO75-B100M8NL4E2P	2A	2A	20 x 16 x 4.5	System power, lock power / four Paxton
6	FPO75-B100D8E4P	FPO75-B100M8NL4E4P	2A	2A	24 x 20 x 6.5	System power, lock power / six Paxton
8	FPO150-B1002D8E6P	FPO150-B100D8M8NL4E6P	4A	4A	30 x 23 x 6.5	System power, lock power / nine Paxton
12	FPO150/250-4D8E8P	FPO150/250-2D82M8NL4E8P	12A	10A	36 x 30 x 6.5	System power, lock power / twelve Paxton
16	FPO150/250-4D8E6P1	FPO150/250-2D82M8NL4E6P1	12A	10A	30 x 23 x 6.5	System power, lock power / sixteen Paxton

System part number can be modified to change output protection Fused outputs = C4, C8, D8, M8 | Class II power limited outputs = C4P, C8P, D8P, M8P

4 Door

6 Door

8 Door

12 Door

16 Door

E2P



20 x 16 x 4.5

E4P

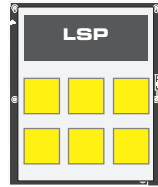

24 x 20 x 6.5

E6P

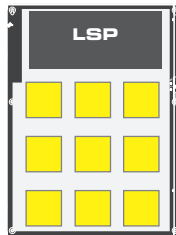

30 x 23 x 6.5

E8P

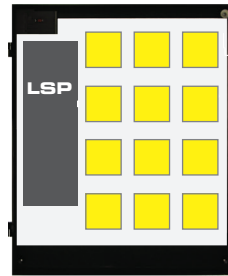

36 x 30 x 6.5

E6P1

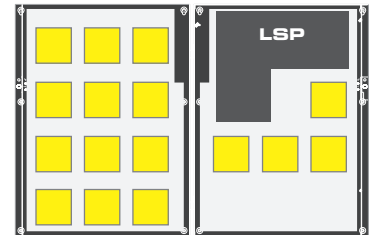

30 x 23 x 6.5

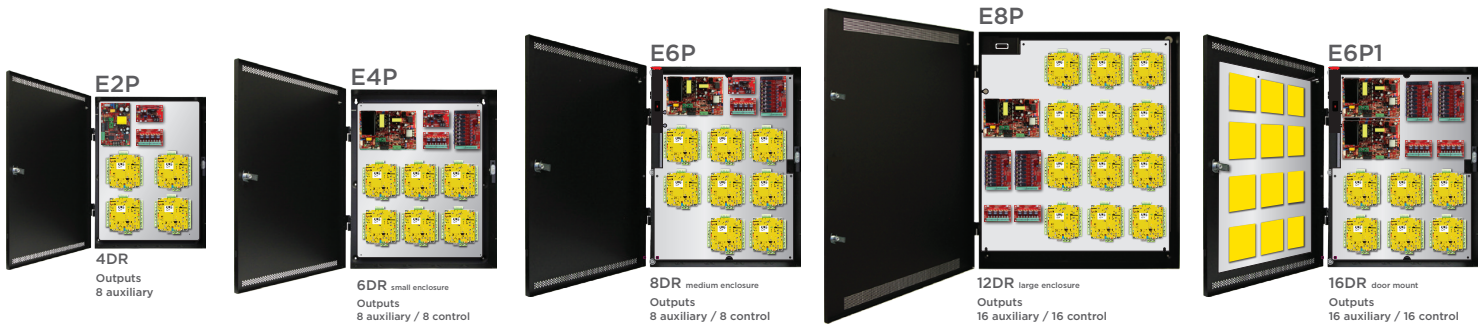

Part numbers in this product guide numbers are most common but many other configurations are possible. Contact Factory Technical Support or visit LSP Website for more information.

The Value of High Level Integrated Power



introducing

LSP
PROWIRE

Now get standardized pre-wired, tested access power systems

eliminates site variation and complexity

Consistency and Standardization
across the enterprise

THREE to ONE
integration - saves wall space and cost

Customized design and High Reliability
operation

Drop Ships
directly **On-site** and delivered on-time

Faster Installation. Easier maintenance and Troubleshooting

Enables operational Efficiencies and Global Standards

Agency Certified
factory wired, labeled and tested



uniform, standardized every site, everywhere

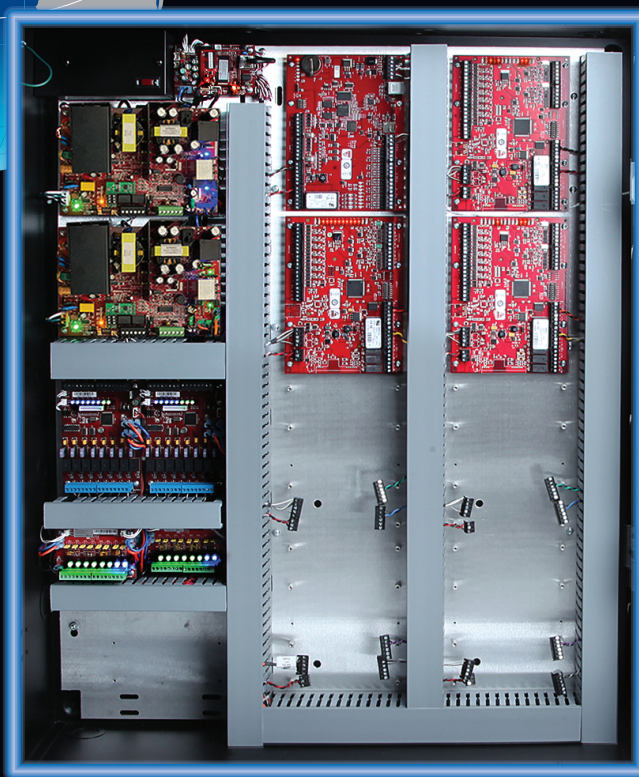

PROWIRE

Mercury | Pre-wired Access Systems

Factory prewired for system power, lock power, communication, faults and tamper switch

Doors	Power/Outputs	Enclosure	Cabling	Base Model	*Wiring	Panel Layout			
4DR	12V/2A and 24V/2A Outputs: STD: 8 aux, 4 lock NET: 8 managed	E2M 20 x 16 x 4.5	Tie wrap	Standard	FPO75-B100C4D8PE2M /	T4-A T4-B T4-C			
				Networked	FPO75-B100M8PNL4E2M /				
		E4M 24 x 20 x 6.5		Standard	FPO75-B100C4D8PE4M /				
				Networked	FPO75-B100M8PNL4E4M /				
8DR	12V/4A and 24V/4A Outputs: STD: 16 aux, 8 lock NET: 16 aux, 8 mgd	E4M 24 x 20 x 6.5	Tie wrap	Standard	FPO150-B100C82D8PE4M /	T8-A T8-B T8-C			
				Networked	FPO150-B1002D8PM8NL4E4M /				
		E4M1 24 x 20 x 6.5		Standard	FPO150-B100C82D8PE4M1 /				
				Networked	FPO150-B1002D8PM8NL4E4M1 /				
		E6M 30 x 23 x 6.5		Panduit style	Standard			FPO150-B100C82D8PE6M /	P8-A P8-B P8-C
					Networked			FPO150-B1002D8PM8NL4E6M /	
		E6M 30 x 23 x 6.5		Panduit style	Standard			FPO150-B100C82D8PE6M /	
					Networked			FPO150-B1002D8PM8NL4E6M /	
16DR	12V/12A and 24V/10A Outputs: STD: 24 aux, 16 lock NET: 24 aux, 16 mgd	E4M1 24 x 20 x 6.5	Tie wrap	Standard	FPO150/250-2C83D8PE4M1 /	T16-A T16-B T16-C			
				Networked	FPO150/250-3D8P2M8NL4E4M1 /				
		E6M1 30 x 23 x 6.5		Standard	FPO150/250-2C83D8PE6M1 /				
				Networked	FPO150/250-3D8P2M8NL4E6M1 /				
		E8M1 36 x 30 x 6.5		Panduit style	Standard			FPO150/250-2C83D8PE8M1 /	P16-A P16-B P16-C
					Networked			FPO150/250-3D8P2M8NL4E8M1 /	
		E8M2 36 x 30 x 6.5		Panduit style	Standard			FPO150/250-2C83D8PE8M2 /	
					Networked			FPO150/250-3D8P2M8NL4E8M2 /	
		E6M1 30 x 23 x 6.5		Panduit style	Standard			FPO150/250-2C83D8PE6M1 /	
					Networked			FPO150/250-3D8P2M8NL4E6M1 /	
		E8M1 36 x 30 x 6.5		Panduit style	Standard			FPO150/250-2C83D8PE8M1 /	
					Networked			FPO150/250-3D8P2M8NL4E8M1 /	
E8M2 36 x 30 x 6.5	Panduit style	Standard	FPO150/250-2C83D8PE8M2 /						
		Networked	FPO150/250-3D8P2M8NL4E8M2 /						
4DR RM	12V/2A and 24V/2A Outputs: STD: 8 lock NET: 8 managed	Mercury GEMINI R2U RACK DRAWER	Tie wrap	Standard	RGM75B-C8PZ /	T4-A T4-B T4-C			
				Networked	RGM75B-M8PNZ /				

*Complete ProWire model number requires base model + wiring suffix (e.g., FPO150-B100C82D8PE6M/T8-A)
Panduit option not available in smaller E2 / E4 enclosures

Controller Wiring Options (e.g. T8-A)

Wire Management
T = Tie wrap
P = Panduit

Door Count
4, 8, 16

Panel Wiring
A, B, C

A

LP1502 / + MR52
4502

B

LP2500 + MR52

C

All MR52's

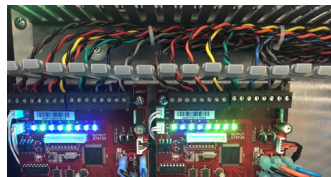

Color coded lock wiring



Data sheets



Wiring Guide





FPO150/250-3D8P2M8NL4 E8M2/P16-A

See ProWire data sheets / wiring guide for detailed specifications

PROWIRE

HID VertX/Aero | Pre-wired Access Systems

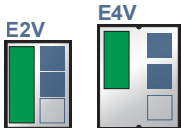
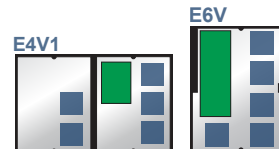
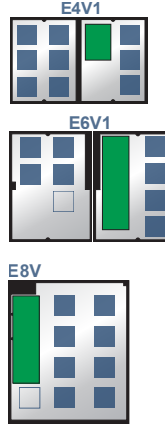
Factory prewired for system power, lock power, communication, faults and tamper switch

Doors	Power/Outputs	Enclosure	Cabling	Base Model		*Wiring	Panel Layout	
4DR	12V/2A and 24V/2A Outputs: STD: 8 aux, 4 lock NET: 8 mgd	E2V 20 x 16 x 4.5	Tie wrap	Standard	FPO75-B100C4D8E2V /	T4-A T4-B		
				Networked	FPO75-B100M8NL4E2V /			
		E4V 24 x 20 x 6.5	Tie wrap	Standard	FPO75-B100C4D8E4V /	T4-A T4-B		
				Networked	FPO75-B100M8NL4E4V /			
8DR	12V/4A and 24V/4A Outputs: STD: 16 aux, 8 lock NET: 16 aux, 8 mgd	E4V1 24 x 20 x 6.5	Tie wrap	Standard	FPO150-B100C82D8E4V1 /	T8-A T8-B		
				Networked	FPO150-B1002D8M8NL4E4V1 /			
		E6V 30 x 23 x 6.5	Tie wrap	Standard	FPO150-B100C82D8E6V /			P8-A P8-B
				Networked	FPO150-B1002D8M8NL4E6V /			
		E6V 30 x 23 x 6.5	Panduit style	Standard	FPO150-B100C82D8E6V /	P8-A P8-B		
				Networked	FPO150-B1002D8M8NL4E6V /			
16DR	12V/12A and 24V/10A Outputs: STD: 24 aux, 16 lock NET: 24 aux, 16 mgd	E4V1 24 x 20 x 6.5	Tie wrap	Standard	FPO150/250-2C83D8E4V1 /	T16-A T16-B		
				Networked	FPO150/250-3D82M8NL4E4V1 /			
		E6V1 30 x 23 x 6.5	Tie wrap	Standard	FPO150/250-2C83D8E6V1 /			P16-A P16-B
				Networked	FPO150/250-3D82M8NL4E6V1 /			
		E8V 36 x 30 x 6.5	Tie wrap	Standard	FPO150/250-2C83D8E8V /	P16-A P16-B		
				Networked	FPO150/250-3D82M8NL4E8V /			
		E6V1 30 x 23 x 6.5	Panduit style	Standard	FPO150/250-2C83D8E6V1 /	P16-A P16-B		
				Networked	FPO150/250-3D82M8NL4E6V1 /			
		E8V 36 x 30 x 6.5	Panduit style	Standard	FPO150/250-2C83D8E8V /	P16-A P16-B		
				Networked	FPO150/250-3D82M8NL4E8V /			
4DR RM	12V/2A and 24V/2A Outputs: STD: 8 aux, 4 lock NET: 8 mgd	VertX GEMINI R2U RACK DRAWER	Tie wrap	Standard	RGV75B-C4D8Z /	T4-A T4-B		
				Networked	RGV75B-M8NZ /			

*Complete ProWire model number requires base model + wiring suffix (e.g., FPO150-B100C82D8E4V1/T8-A)
Panduit option not available in smaller E2/E4 enclosures

Controller Wiring Options (e.g. T8-A)

Wire Management
T = Tie wrap
P = Panduit

Door Count
4, 8, 16

Panel Wiring
A, B, C

A  V1000 + V100

B  All V100's

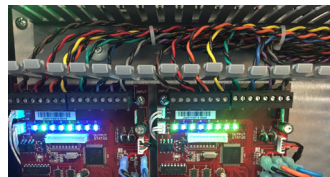

See ProWire data sheets / wiring guide for detailed specifications

PROWIRE

AMAG | Pre-wired Access Systems

Factory prewired for system power, lock power, communication, faults and tamper switch

Doors	Power/Outputs	Enclosure	Cabling	*Base Model		Wiring	Panel Layout
8DR	12V/4A and 24V/4A Outputs: STD: 8 aux, 8 lock NET: 8 aux, 8 mgd	E4A 24 x 20 x 6.5	Tie wrap	Standard	FPO150-B100C8D8E4A /	T8-A T8-C	
				Networked	FPO150-B100D8M8NL4E4A /		
		E6A 30 x 23 x 6.5	Tie wrap	Standard	FPO150-B100C8D8E6A /	T8-A T8-C	
				Networked	FPO150-B100D8M8NL4E6A /		
			Panduit style	Standard	FPO150-B100C8D8E6A /	P8-A P8-C	
				Networked	FPO150-B100D8M8NL4E6A /		
16DR	12V/12A and 24V/10A Outputs: STD: 8 aux, 16 lock NET: 8 aux, 16 mgd	E6A1 30 x 23 x 6.5	Tie wrap	Standard	FPO150/250-2C82D8E6A1 /	T16-A T16-C	
				Networked	FPO150/250-2D82M8NL4E6A1 /		
			Panduit style	Standard	FPO150/250-2C82D8E6A1 /	P16-A P16-C	
				Networked	FPO150/250-2D82M8NL4E6A1 /		
		E8A 36 x 30 x 6.5	Tie wrap	Standard	FPO150/250-2C82D8E8A /	T16-A T16-C	
				Networked	FPO150/250-2D82M8NL4E8A /		
			Panduit style	Standard	FPO150/250-2C82D8E8A /	P16-A P16-C	
				Networked	FPO150/250-2D82M8NL4E8A /		
8DR RM	12V/12A Outputs: STD: 8 auxiliary NET: 8 auxiliary	RGA RACK DRAWER	Tie wrap	Standard	RGA150-D8Z /	T8-A T8-C	
				Networked	RGA150-D8NZ /		
	Standard			RGA150B-F8Z /			
	Networked			RGA150B-NZ /			
12V/4A & 24V/4A Outputs: STD: 8 FAI lock							

*Complete ProWire model number requires base model plus a wiring suffix (e.g., FPO150-B100C8D8E6A/T8-A)
Panduit option not available in smaller E4 enclosure

RGA network configuration does not have managed (M8) outputs due to drawer space limits

Controller Wiring Options (e.g. T8-A)

Wire Management
T = Tie wrap
P = Panduit

Door Count
4, 8, 16

Panel Wiring
A, C

A

M2150

C



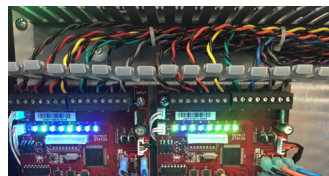

M4000



PROWIRE

Honeywell ProWatch | Pre-wired Access Systems

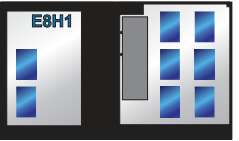
Factory prewired for system power, lock power, communication, faults and tamper switch

Doors	Power/Outputs	Enclosure	Cabling	Base Model	*Wiring	Panel Layout
4DR	12V/2A and 24V/2A Outputs: STD: 8 aux, 4 lock NET: 8 mgd	E4H 24 x 20 x 6.5	Tie wrap	Standard FPO75-B100C4D8PE4H /	T4-C T4-D	
				Networked FPO75-B100M8PNL4E4H /		
8DR	12V/4A and 24V/4A Outputs: STD: 16 aux, 8 lock NET: 16 aux, 8 mgd	E8H 36 x 30 x 6.5	Tie wrap	Standard FPO150-B100C82D8PE8H /	T8-C T8-D	
				Networked FPO150-B1002D8PM8NL4E8H /		
		E8H 36 x 30 x 6.5	Panduit style	Standard FPO150-B100C82D8PE8H /	P8-C P8-D	
				Networked FPO150-B1002D8PM8NL4E8H /		
16DR	12V/12A and 24V/10A Outputs: STD: 24 aux, 16 lock NET: 24 aux, 16 mgd	E8H1 36 x 30 x 6.5	Tie wrap	Standard FPO150/250-2C83D8PE8H1 /	T16-C T16-D	
				Networked FPO150/250-3D8P2M8NL4E8H1 /		
		E8H1 36 x 30 x 6.5	Panduit style	Standard FPO150/250-2C83D8PE8H1 /	P16-C P16-D	
				Networked FPO150/250-3D8P2M8NL4E8H1 /		
4DR RM	12V/2A and 24V/2A Outputs: STD: 8 aux, 4 lock NET: 8 mgd	RGH GEMINI R2U RACK DRAWER	Tie wrap	Standard RGH75B-C8PZ / Networked RGH75B-M8PNZ /	T4-C T4-D	

*Complete ProWire model number requires base model + wiring suffix (e.g., FPO150-B100C82D8PE8H/T8-C)
Panduit option not available in smaller E4 enclosures

Controller Wiring Options (e.g. T8-C)

Wire Management
T = Tie wrap
P = Panduit

Door Count
4, 8, 16

Panel Wiring
C, D

C

PW7K1C / PW7K1R2



D

All PW7K1R2



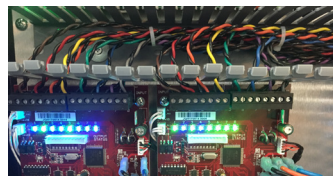

Color coded lock wiring



Data sheets



Wiring Guide



16 door ProWire Panduit
FPO150/250-3D8P2M8NL4E8H1/P16-C

See ProWire data sheets / wiring guide for detailed specifications

Award winning web managed wall mount / rack mount power systems

Value Added Managed Services
 24/7 power monitoring, battery health reporting, device trouble alerts

Monitoring of

- ◆ **Total System Health** Faults, output draw, battery state, temperatures
- ◆ **Output Condition** Current draw, voltage level and output status
- ◆ **Battery Activity** Charging current, discharge level, time to service
- ◆ **Power History** AC outages, time stamped faults, enclosure tampering

Notifies

- ◆ If AC is lost or restored
- ◆ When a Fire Alarm Input is activated
- ◆ If cameras or locks are drawing beyond their rated current
- ◆ When batteries are at low critical level

Controls

- ◆ Drop egress locks on Fire Alarm or loss of AC
- ◆ Use for lock control, camera reboot or other reset functions
- ◆ Scheduled or manual battery checks

Saves

Each time typical on-site service functions are done remotely

- ◆ Instant system access via smartphone, iPad, PC, etc.
- ◆ AC loss or trouble faults investigated
- ◆ Misbehaving locks or cameras power cycled
- ◆ Live monitoring of remote or dangerous areas
- ◆ Batteries tested remotely

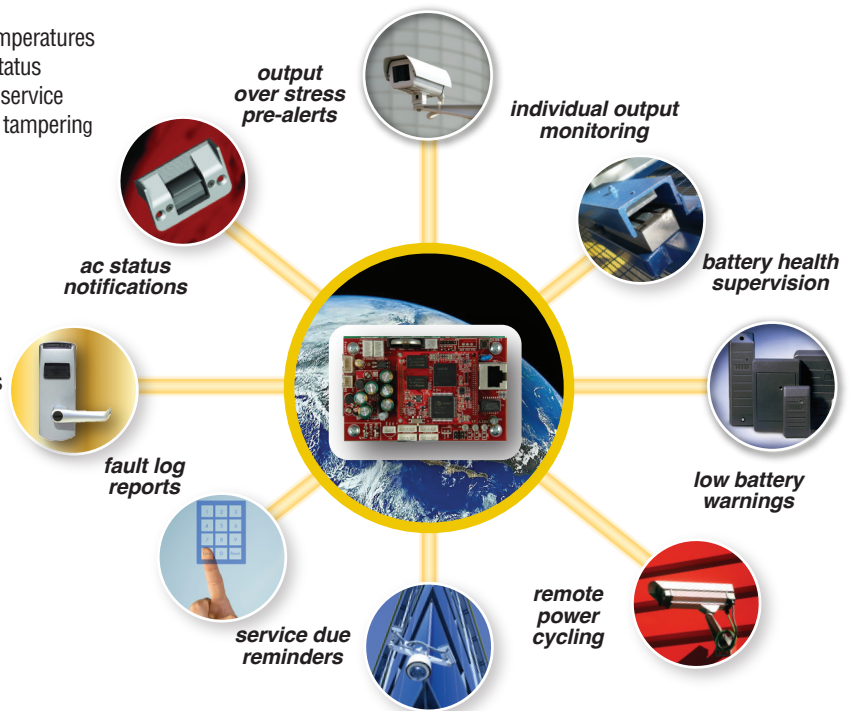

Power system dashboard



Remote output management

Device ID: M8-1		Model: M8		AC Power: ON					
Output #	Output Description	Voltage (V)	Current (A)	Power (W)	Power Ready	Control Input	FAI State	Output Status	
<input type="checkbox"/>	1 Lobby door	25.136	0.210	5.278	Yes	Inactive	Disabled	Normal	
<input type="checkbox"/>	2 Maglock 1	0.000	0.000	0.000	Yes	Inactive	Active	Normal	
<input type="checkbox"/>	3 Maglock 2	24.298	0.270	6.477	Yes	Inactive	Disabled	Fault	
<input type="checkbox"/>	4	0.000	0.000	0.000	Yes	Disabled	Disabled	Normal	
<input type="checkbox"/>	5	0.000	0.000	0.000	Yes	Disabled	Disabled	Normal	
<input type="checkbox"/>	6 Back parking	12.227	0.039	4.879	Yes	Active	Disabled	Normal	
<input type="checkbox"/>	7 Doorstrike 1	12.286	0.375	4.435	Yes	Active	Active	Normal	
<input type="checkbox"/>	8 Front parking	12.286	0.464	5.555	Yes	Inactive	Disabled	Normal	

Enable Selected Outputs
Disable Selected Outputs
Enable All Outputs
Disable All Outputs
Save Settings

Applications

- ◆ Supervise lock and camera operating power for over stress
- ◆ Power cycle DC cameras, NVRs, DVRs or any edge device
- ◆ Live monitoring of remote or dangerous areas
- ◆ Room temperature change alert for labs and server rooms
- ◆ Lock fail pre-alert for banks, casinos, high security etc.

EMAIL / SNMP notification

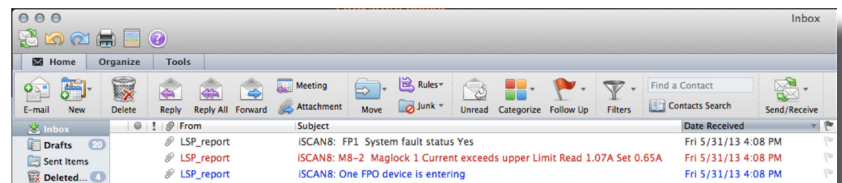

Pre-configured Network Systems

Model	Power	System	Current / Voltage	Outputs		Enclosure
				Auxiliary	Managed	
<i>Wallmount</i>						
ISCAN250-8	250W	Single Voltage	12A/12V or 6A/24V	8	8	20H x 16W x 4.5D
ISCAN250-16	250W	Single Voltage	12A/12V or 6A/24V	16	16	20H x 16W x 4.5D
ISCAN250-24	250W	Single Voltage	20A/12V or 10A/24V	24	24	24H x 20W x 6.5D
ISCAN250B-8	250W	Dual Voltage	4A/12V and 8A/24V	8	8	20H x 16W x 4.5D
ISCAN250B-16	250W	Dual Voltage	4A/12V and 8A/24V	16	16	24H x 20W x 6.5D
ISCAN75/75-8	150W	Dual Voltage	6A/12V and 3A/24V	8	8	20H x 16W x 4.5D
ISCAN150/250-16	400W	Dual Voltage	12A/12V and 10A/24V	16	16	24H x 20W x 6.5D

More configurations available - consult factory

Model	Power	System	Current / Voltage	Managed Outputs		Enclosure
				Auxiliary	Managed	
<i>Rackmount</i>						
RS75-M8	75W	Single Voltage	6A/12V or 3A/24V	8	8	R2U
RS150-M8	150W	Single Voltage	12A/12V or 6A/24V	8	8	R2U
RS150-M16	150W	Single Voltage	12A/12V or 6A/24V	16	16	R2U
RS250-M8	250W	Single Voltage	20A/12V or 10A/24V	8	8	R2U
RS250-M16	250W	Single Voltage	20A/12V or 10A/24V	16	16	R2U
RS250B-M8	250W	Dual Voltage	4A/12V and 8A/24V	8	8	R2U
RS250B-M16	250W	Dual Voltage	4A/12V and 8A/24V	16	16	R2U

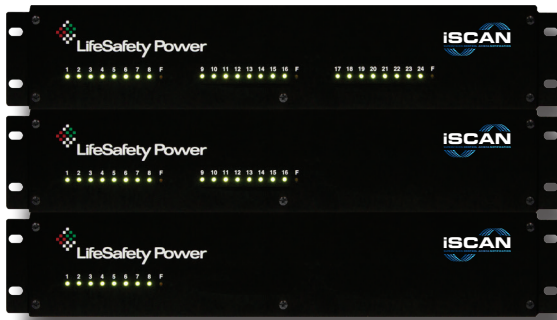

Rackmount / Wallmount

- ◆ Single voltage up to 250W
- ◆ Dual voltage up to 400W

Multiple outputs / maximum flexibility

- ◆ 8 - 24 managed outputs for critical device monitoring
- ◆ Auxiliary outputs for non-critical devices (wallmount only)

Large enclosures for future expansion

- ◆ Increase power or add additional outputs
- ◆ Add more battery capacity



ISCAN250B-8



manage and control access power across every location through a single interface

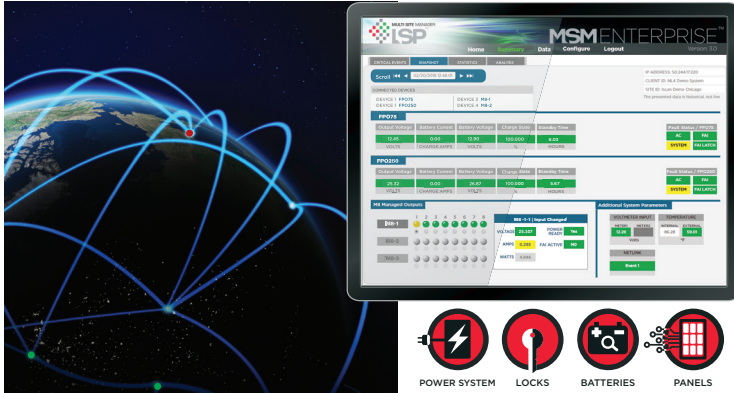

Ordering

MSM25

Description

25 System License Block for MSM-Enterprise

(Combine license blocks to add systems in increments of 25)

[Free demo available \(4 system max\). See page 4 for download instructions](#)

Overview

The MSM-Enterprise software package allows the user to manage, control, and analyze hundreds of LifeSafety Power networked power systems across multiple locations through one user interface. A PC-driven platform using a robust software database, MSM-Enterprise lets users gain real-time insights into critical information and data related to their networked power solutions, allowing proactive performance assessment through managed power services.

Multiple Data Screens For Event Analysis

Enterprise view - all sites



Site view



Site statistics

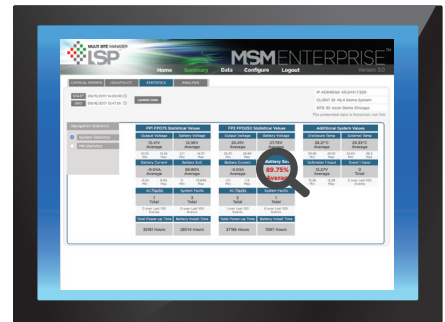

Critical events



Event analytics



Event log



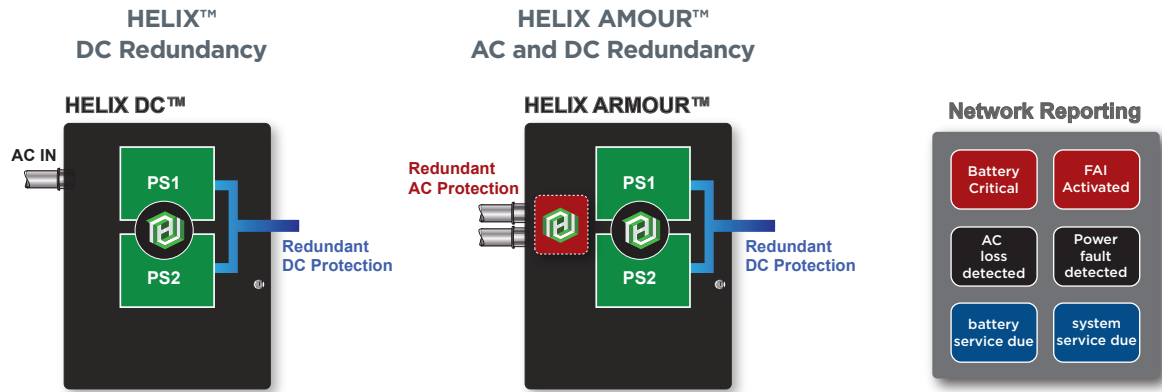

configurations also available in rackmount *contact factory for details*

HELIX AMOUR™ AC & DC Model Configuration

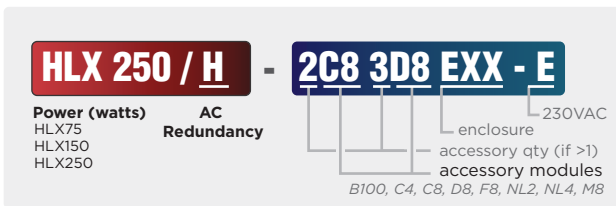

Redundant AC & Redundant DC System			
Input	Output**	Model No.	Outputs
120 VAC	12V or 24V	HLX150/H-NL4E2	1
	12V or 24V	HLX150/H-D8NL4E2	8
	12V or 24V	HLX150/H-2D8NL4E2	16
208 or 230 VAC	12V or 24V	HLX150/H-NL4E2/E	1
	12V or 24V	HLX150/H-D8NL4E2/E	8
	12V or 24V	HLX150/H-2D8NL4E2/E	16

**User sets either a 12 or 24V output

HELIX™ DC Model Configuration



Redundant DC Wallmount System			
Input	Output**	Model No.	Outputs
120 VAC	12V or 24V	HLX150-NL4E2	1
	12V or 24V	HLX150-D8NL4E2	8
	12V or 24V	HLX150-2D8NL4E2	16
208 or 230 VAC	12V or 24V	HLX150-NL4E2/E	1
	12V or 24V	HLX150-D8NL4E2/E	8
	12V or 24V	HLX150-2D8NL4E2/E	16

**User defines output voltage

HELIX™ Mission Critical Protection

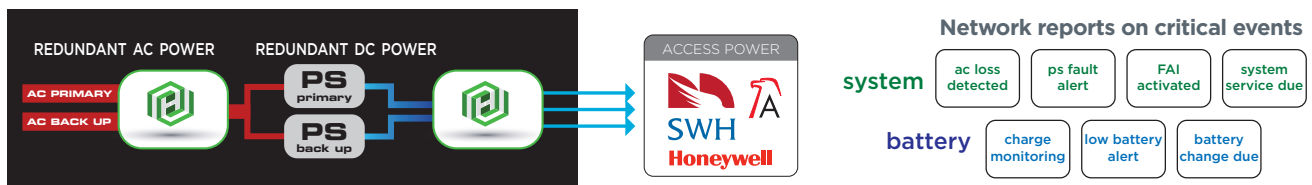

HELIX GENERAL SPECIFICATIONS

INPUT	Input 120VAC / 230VAC 50/60 Hz	BATTERY CHARGING	Independent built-in lead acid battery charger
	Thermal overload protection		Dual rate charging of 12 or 24V battery sets
	Short circuit protection		Auto transfer to battery when AC fails
OUTPUT	DC1 continuous output	AC SUPERVISION	Management of AC line (/H models)
	120 mV output voltage ripple		120 mV output voltage ripple
	Power distribution: user defined		Power distribution: user defined
INTERNAL PS INDICATORS	AC input and DC1 output	DC SUPERVISION	Power Supply, battery sets, external temperature
	System and AC Faults		Email, SNMP, XML reporting
	Ground fault, reverse battery		
EXTERNAL INDICATORS	AC On	AGENCY LISTING	UL294, UL603, UL1076, ULC S318, S319 CSA C22.2 #107.1 / CSA 22.2 #60950 CE
	Distributed outputs		

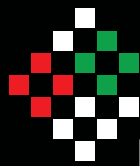

LifeSafety Power®

Corporate Headquarters

Phoenix, AZ 85044 USA
888-577-2898 Toll Free
www.lifesafetypower.com

Agency Listings

- UL294, UL2610 | ULC S319
- CSA C22.2 #107.1
- FCC Part 15 Subpart B
- IEC 62368-1:2014, EN55032:2015, EN61000-3-2:2014
- EN61000-3-3:2013, EN55024:2010 +A1:2015
- CE | UKCA | BIS IS13252(Part1):2010 | NOM 001:2018 | RCM, SAA
- CSFM approved | ROHS 3 Leadfree